

ATS-22A Ver1.0

Automatic Transfer Switch Control Unit Operation Manual



KUTAI ELECTRONICS INDUSTRY CO., LTD.

TEL : +886-7-8121771

FAX : +886-7-8121775

Website : www.kutai.com.tw

Headquarters : No.3, Ln. 201, Qianfu St., Qianzhen Dist., Kaohsiung City 806037, Taiwan



TABLE OF CONTENTS

Section	Page
SECTION 1 : INTRODUCTION	
1.1 Preliminary Comments And Safety Precautions.....	3
1.2 Overview	3
1.3 Product Overview.....	3
1.4 Functions / Features	3
SECTION 2 : OPERATOR PANEL	
2.1 General	5
2.2 Display Window	5
2.3 Function Buttons	5
2.4 Panel LED Outputs	5
SECTION 3 : OPERATION	
3.1 General	6
3.2 AUTO Mode	6
3.3 OFF Mode	6
3.4 Manual Test Mode (TEST)	7
3.5 Programming Instruction.....	7
3.6 Remote Communication Instruction.....	7
3.7 KCU Remote Connection Passwords Recovery	8
3.8 Voltage Adjustment.....	8
3.9 Line By Line Programming Table	10
3.10 Specification Summary	11
SECTION 4 : INSTALLATION INSTRUCTIONS	
4.1 General	12
4.2 Figure / Size / Installation Reference.....	12
SECTION 5 : TYPICAL WIRING	
APPENDIX : KCU Modules Connection Illustration	37

SECTION 1 : INTRODUCTION

1.1 Preliminary Comments and Safety Precautions

The manual covers installation, operation and maintenance of the ATS-22A Automatic Transfer Switch PLC Controller. This manual is for use by authorized and qualified personnel only.

<p style="text-align: center;">WARNING</p>

<p style="text-align: center;">High voltage will cause severe injury or death</p>
--

1.2 Overview

Transfer switches protect critical electrical loads against loss of power. A standby (emergency) generator backs up the normal grid power. The transfer switch connects Normal and Standby source supply to the load. When power is lost from Normal source, the transfer switch transfers the load to the standby source. After power is restored, the ATS will transfer the load back to Normal source.

1.3 Product Overview

The ATS-22A is a multifunction programmable logic automatic transfer switch controller. Suitable for 1 phase and 3 phase system, including all necessary monitoring and protections.

Controller's features :

- Microprocessor based & Polycarbonate panel.
- Membrane switch button designed. *1
- Compact size with user-friendly LED display.
- Programmable for cycle-mode or fix-mode displays for 3-phase and 1-phase voltages and frequencies.
- All programming and operations can be configured on the front panel.
- Monitors Normal and Standby power for Over / Under voltage anomalies.
- Monitors Normal and Standby power for Over / Under frequency anomalies.
- Exercise with or without load.
- 1 week to 4 weeks automatic scheduled exercise / testing.
- Transfer failure output signal.
- Pre-alert warning signal output for transferring operation.
- Pre-alert warning signal output for scheduled automatic Exercise / testing.
- Compatible with most ATS switches on the market.
- Communication Port for Remote Monitoring and Control Options. (USB / RS485 / Ethernet / WI-FI modules SIM Card). *1
- Program on-site or from remote (mobile) device (PC, Smartphone). *2

- Auto-saved settings (memory preserved throughout all power disconnects and resets).
- Front panel display provides source status and fail alarm indications.

1.4 Functions / Features

The primary function of ATS-22A controller is to monitor Normal / Standby power and to provide seamless automatic transfer of load.

1.4.1 Operational Simplicity

From installation to programming and to usage, the ATS-22A controller is designed with operational simplicity in mind. The user-friendly front panel interface simplifies routine operation, programming and setting adjustments.

1.4.2 Standard Features

All logic settings for different ATS's are preprogrammed and stored in its non-volatile random-access memory (NVRAM), this memory retains its information when power is turned off. Some features and set points are user adjustable.

*1 Software version REV.3, REV.3.1 ,REV.4 are not available for remote communication. System voltage 180 Vac or above is required to use with optional KCU-40 or KCU-50 communication module.

*2 KCU communication module option is required.

Feature 1 : Time Delay Emergency to Normal (TDEN)

TDEN delays the transfer from the emergency source to the normal Source to permit stabilization of the normal source before retransfer is made. Timing begins when the normal source becomes available. (Refer to program table line 3)

Adjustable TDEN time range : 00 – 999 sec.

Feature 2 : Time Delay Normal to Emergency (TDNE)

TDNE delays the transfer from normal to emergency to permit stabilization of the generator before the retransfer is made. Timing begins when the standby source becomes available. (Refer to program table line 4)

Adjustable TDEN time range : 00 – 250 sec.

Feature 3 : Time Delay Engine Start (TDES)

The TDES Time (Delays Engine Start) this timer prevents nuisance start because of momentary electrical glitches. If power normalizes before the countdown ends, the controller skips the engine start and resets the timer. (Refer to program table line 5)

Adjustable TDES time range : 00 – 30 sec.

Feature 4 : Time Delay Engine Cool-down (TDEC)

TDEC permits the generator to run unloaded after the ATS retransfer back the load to Normal source. Timing begins when the ATS connects back to Normal source. (Refer to program table line 6)

Adjustable TDEC range : 00 – 250 sec.

Feature 5 : Time Delay Center OFF Position

This timer temporarily stops the switch in the center OFF position (completely cut off) before proceeding to Normal source. (Refer to program table line 7)

Adjustable time delay range : 00 – 99 sec.

Feature 6 : Full Phase Over / Under Voltage and Loss of Phase Sensing

The controller monitors full phase output voltage from Normal and Standby source. The user can program over & under voltage window. (Refer to program table line 8, 9, 10, 14, 15 & 16)

O/V adjustment range : 110 – 530 Vac

O/V reset value : -10 Vac (Not adjustable)

U/V adjustment range : 80 – 470 Vac

U/V reset value : +10 Vac (Not adjustable)

Feature 7 : Under / Over Frequency Sensing

The controller monitors Normal and Standby source frequency. The client can set the over & under frequency range. (Refer to program table line 11, 12, 13, 17, 18 & 19)

O/F adjustable range : 51 – 75 Hz

O/F reset value : -1 Hz (Not adjustable)

U/F adjustable range : 40 – 59 Hz

U/F reset value : -1 Hz (Not adjustable)

Feature 8 : Programmable exerciser

It can be set to exercise one time per week to one time every 4 weeks on any day and time, with or without load. The length of the exercise is also set. (Refer to program table line 23, 24, 25, 26 & 27)

Feature 9 : Failure Warning Output

The controller also has one dry contact that can be set to react to one of four warning. (Refer to program table line 30)

- Transfer failure warning
- Pre-transfer warning
- Pre-test / exercise warning
- When ATS is in emergency position warning

NOTICE

ATS-22A provides one auxiliary contact for external output signal for Transfer Failure, Pre-transfer or Pre-exerciser alarm output.

Feature 10 : Controller Panel Lighting Test

This checks the LED lights. Press the OFF button twice, all panel LEDs must light up.

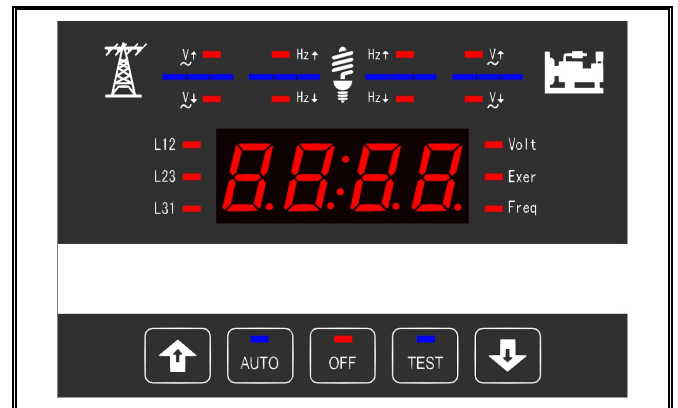

SECTION 2 : OPERATOR PANEL

2.1 General

Get acquainted with the ATS-22A :

- Front Display Window
- Function Buttons
- Panel LEDs Display

2.2 Display Window

The ATS-22A controller has a four-digit, seven-segment displayer to monitor all parameters, setting and messages.

The screen display's :

- Full phase voltage / frequency display
- Current Time HH : MM (In OFF only)
- Time delay countdown display
- Program setting parameter display



2.3 Function Buttons

The front panel employs five membrane switch buttons.

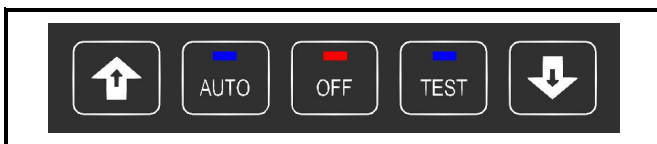

2.3.1 Increase (▲) Button

In AUTO Mode, each press of the up (▲) button changes the display to the next phase voltage reading.

However, when programming every press of the up (▲) button increases the displayed parameter by a single unit. If held, the up (▲) button continues to scroll.

2.3.2 Decrease (▼) Button

In AUTO Mode, each press of the down (▼) button changes the display between voltage, duty time and frequency.

However, when programming every press of the down (▼) button decreases the displayed parameter by a single unit. If held, the down (▼) button continues to scroll.

2.3.3 AUTO Button

When selecting the AUTO button, the ATS-22A runs in automatic mode (AUTO) lighting the corresponding LED to indicate the selection. The controller automatically starts the generator, transfer and retransfers from Normal to Standby source as commanded by the features supplied and the preprogrammed setting.

2.3.4 TEST Button

Pressing the TEST button simulates a power failure. In TEST the generator starts and begins a preprogrammed execution and testing sequence made with or without loading the generator. (Refer to program line 28)

2.3.5 OFF Button

Pressing the OFF again, turns the ATS-22A OFF engaging a flashing red LED instantly disabling all functions and the screen shows the current time.



2.4 Panel LED Outputs

Eight individual red and blue LEDs light bars perform or indicating each function.

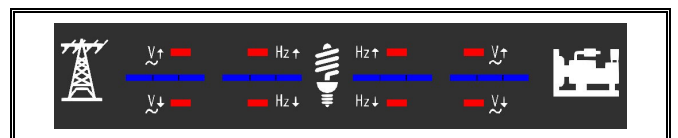

Information concerning the LEDs output

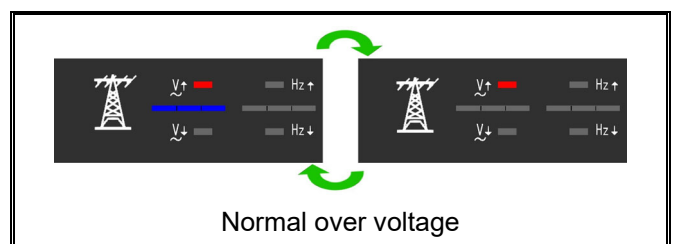
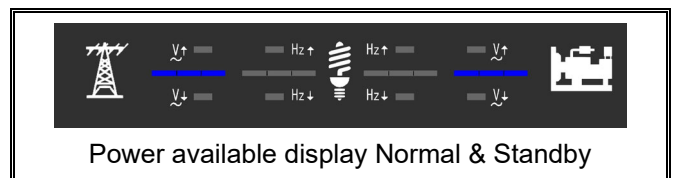

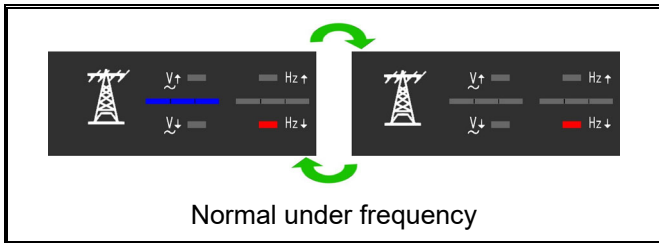
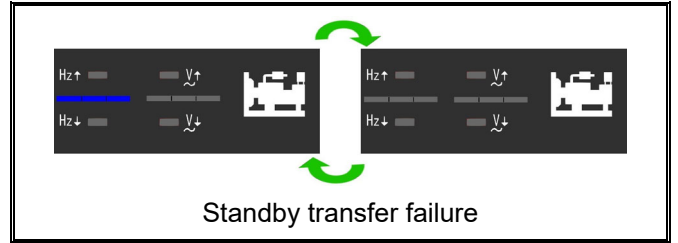
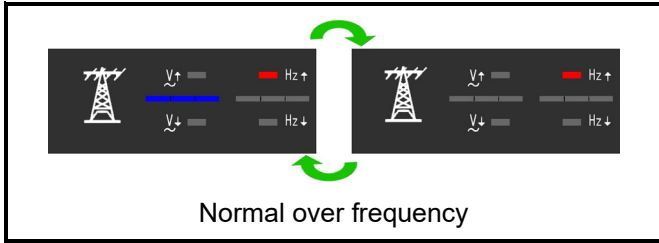
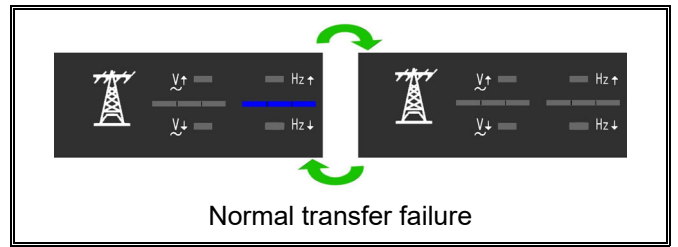
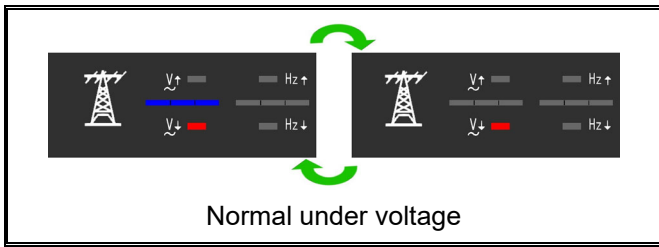

SECTION 3 : OPERATION

3.1 General

The five functions of the ATS-22A :

- AUTO Mode
- OFF Mode
- Manual Test Mode (TEST)
- Programming Instruction
- Remote Communication Instruction

The practical use of each operation under each category will be explained in this section. It is assumed that prior sections are understood, and the operator has a basic understanding of the hardware.

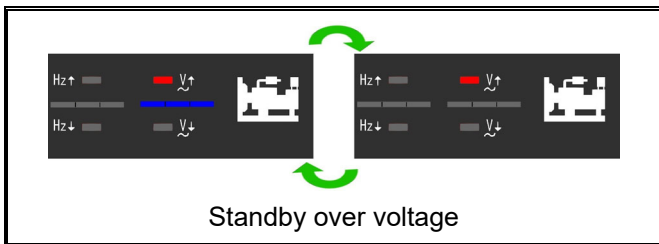

3.2 AUTO Mode

The AUTO mode provides automatic engine start, stop, and power transfer and retransfers from source to source as dictated by the values previously programmed.

The ATS-22A constantly monitors the condition of both Normal and Standby source.

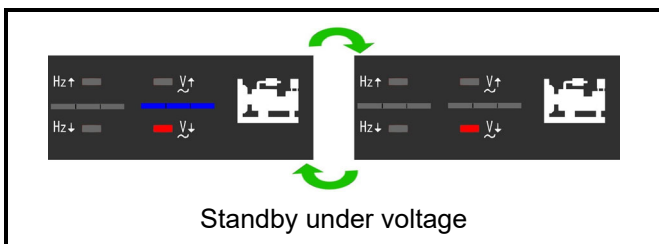

3.3 OFF Mode

In OFF mode, the ATS-22A disables all the transfers and protection functions with all LED indicators off leaving the display screen only showing the time. User can test the LEDs by pressing the OFF button twice. Check and reset the clock every year. The wrong time can affect the schedule exerciser. Without power, the controller can maintain the clock working for up to a week.

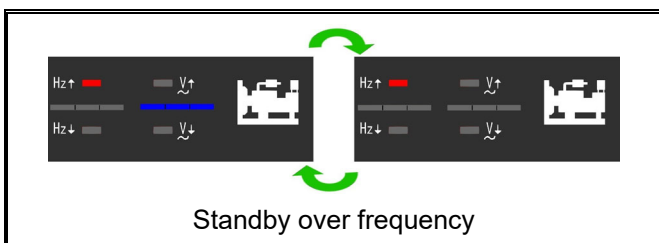

However, when programming, the OFF button allows you to move to the next program line and then change the values for that line using down (▼) and up (▲) buttons.

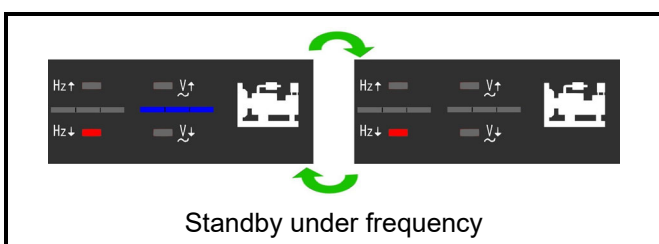

3.4 Manual Test Mode (TEST)

Pressing TEST simulate a loss of Normal power source. Permitting the controller to start the engine and carry out a power transfer. TEST can be with load or without load.

To end, press the AUTO button. If Normal power is available, the controller transfer back to Normal and the engine follow the program shutdown procedure to stop the generator. However, by pressing the OFF button, the transfer switch remains in its current position stopping the engine, and bypassing all time delays.

3.5 Programming Instruction

Program the controller from the front faceplate.

To start, set the controller to OFF and press & hold the OFF button for 4 seconds. The word "Vr1.0" appears on the display for 2 seconds, showing the software version.

You are now ready to start the line-by-line programming sequence. Always press the OFF button to move to the next line. To change the parameter, on each line use the up (▲) and down (▼) arrows. Repeatedly pressing the up (▲) or down (▼) button, changes the displayed by one. To change faster, hold the buttons down.

Remember to always press the "OFF" button to move to the next line or until the "End" appears on the screen.

Note : To end and exit at any time, hold the "OFF" button down for 4 seconds.

If you make an error or need to return to factory settings, stay or reenter programming and then hold the AUTO button down for 4 seconds, until the word "Au.Po" appears on the screen verifying that all programming lines are factory reset back like in the manual. (See line-by-line programming table for ATS-22A factory settings).

3.6 Remote Communication Instruction

You can monitor and control ATS on a remote PC/Smartphone using the remote communication modules manufactured by Kutai Electronics.

Model	Communication interface
KCU-01	USB
KCU-02	RS-485
KCU-30	Ethernet (Dynamic IP)
KCU-40	WI-FI
KCU-50	3G SIM Card

WARNING

A remote start signal can start an engine via ATS-22A without warning. Place a "Danger" sign next to the generator stating it can start anytime! A warning buzzer / light installed is recommended. Unexpected engine starts can result in serious injury or death. When performing service or maintenance, always disconnect the remote start signal input.

When KCU-30, KCU-40, KCU-50 module is installed on ATS-22A, it allows you to remote monitor or operate ATS and generator via iphone or Android mobil phones. Free App software currently available for Apple iOS5.1 system or above and android operating system.

Download "**Remote Communication**" free software by searching "Kutai" in Apple Store or Google Play.

The corresponding program settings for ATS-22A installed with KCU-XX module includes item (32), (33), (34) Programming item (32) is a must. When Item (32) is set to "00" Disable, then the remote monitoring software is restricted to read information only whereas remote command is strictly forbidden.

When KCU-02 – RS-485 communication module is installed, additional program setting on lines (33) and (34) are required.

Refer to KCU-XX hardware and software manual for detail information

WARNING

ATS-22A with KCU-02 module constitutes a closed LAN network. Each controller address can be setup range from 1 to 99 and not to be repeated. The transmission rate must be the same!

The installation for the KCU-XX communication module on the ATS-22A controller is fairly simple.

Step 1 : Remove the slot cover from the back of controller.

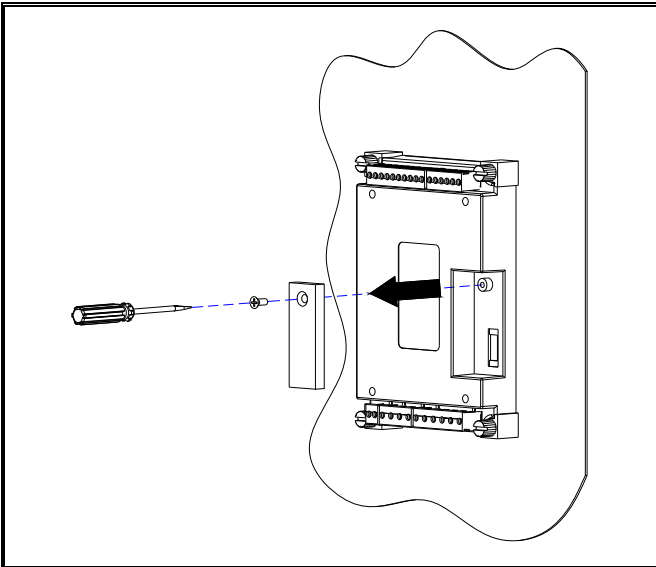

Step 2 : Insert KCU-XX module into the slot and tighten the screw.

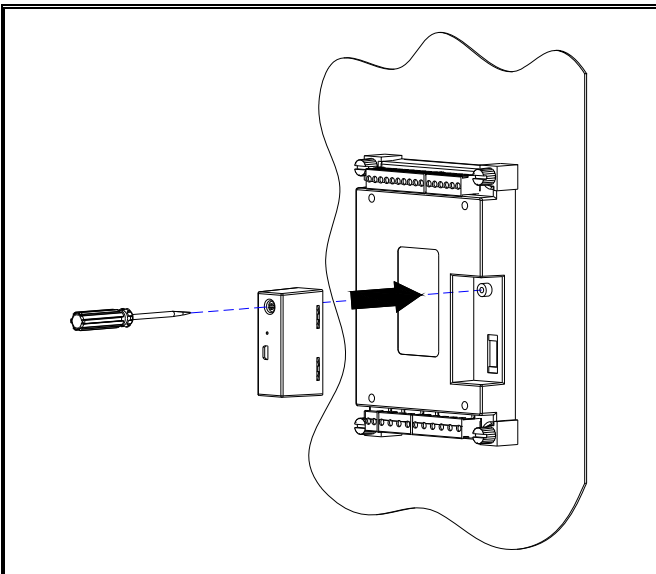

3.7 KCU Remote Connection Passwords Recovery

Step 1 : Make sure the KCU module is installed on the controller before carrying out remote connection passwords recovery.

Step 2 : Enter Program mode and set the program item (36) to (01) and press OFF button. 4-digit numbers "0000" and "9999" will appear on the display window about two seconds. Then "End" appears which means passwords have been restored successfully.

NOTICE

Program Line 36 is only available when KCU Module is installed on the ATS-22A controller.

3.8 Voltage Adjustment

The ATS-22A voltage readings are factory set and calibrated. However, if you need to modify any voltage reading, follow these steps.

Step 1 : Ensure supply is connected to both the normal and standby line sides before undertaking Voltage calibration, and then manually start standby generator to generate power.

Step 2 : Enter Program mode and set the program item (35) to (01). "VAdJ" will appear on the display window.

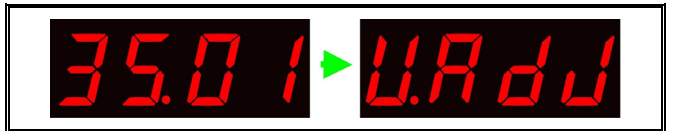

Step 3 : Select the phase you wish to re-calibrate by pressing the OFF button.

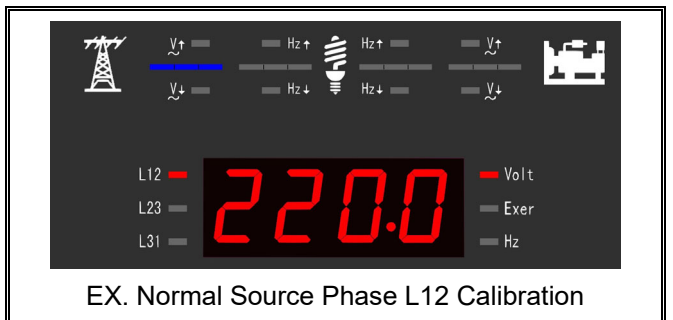

Step 4 : Use a good quality voltmeter as a reference to calibrate the ATS-22A voltage reading to the desired phase.

Step 5 : With the up (▲) and down (▼) buttons reset the voltage reading on the ATS-22A.

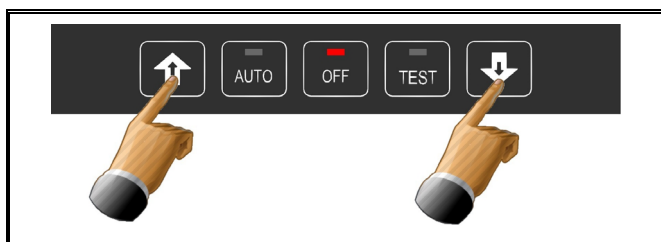

Step 6 : Press the “OFF” button to move to the next phase or until the word “End” appears on the screen. To exit hold the “OFF” button at any time for 4 sec.



Step 7 : If you get “FAIL”, the calibration is null. Press the OFF button to reset and repeat Step 1.



SECURITY NOTICE AND LIABILITY DISCLAIMER

You are responsible for keeping your KCU Remote Connection Passwords (Administrator/Viewer) safe and confidential because they are the key to access your equipments.

There will be potentially serious security issues if your passwords are compromised. Some of the risks of compromised security include the equipment being remotely controlled by third parties, who may have criminal intent and malicious damage to your equipments.

We are entitled to rely on any use of our connection services using that password as being use by you and authorized by you. If you know or believe that there is any unauthorized, fraudulent or unlawful use of your password, you must reset it in the controller. (Refer to controllers user manual for connection password reset)

3.9 Line By Line Programming Table

Line	Description	Value	Factory Setting
1	Is this ATS operating in 1 Phase or 3 Phase?	00 → 1 Phase 01 → 3 Phase	01
2	Select Switch ATS type See drawing on the back of this manual for guide on different ATS types	00) MCCB BTS type ATS (Single motor) 01) Mot type (MCCB with separate motor) 02) Air circuit breaker type (ACB) 03) Double throw type (Without OFF position) 04) Double throw type (With OFF position) 05) Kutai TS-XXX type ATS 06) Magnetic contactor type ATS (MC)	00
3	TDEN Time Delay Emergency to Normal	00 – 999 sec.	10 sec.
4	TDNE Time Delay Normal to Emergency	00 – 250 sec.	10 sec.
5	TDES Time Delay Engine Start	00 – 30 sec.	5 sec.
6	TDEC Time Delay Engine Cool-down	00 – 250 sec.	30 sec.
7	Time Delay in the OFF Position	00 – 99 sec.	5 sec.
8	Normal over voltage protection setting	11 – 53 (110 – 530V)	25 (250V)
9	Normal under voltage protection setting	08 – 47 (80 – 470V)	18 (180V)
10	Time delay if there is a problem with the Normal voltage	00 – 99 sec. (0 = Disable voltage monitoring)	10 sec.
11	Normal over frequency protection setting	51 – 75 Hz	65 Hz
12	Normal under frequency protection setting	40 – 59 Hz	55 Hz
13	Time delay if there is a problem with the Normal frequency	00 – 99 sec. (0 = Disabled Hz monitoring)	10 sec.
14	Generator over voltage protection setting	11 – 53 (110 – 530V)	25 (250V)
15	Generator under voltage protection setting	8 – 47 (80 – 470V)	18 (180V)
16	Time delay if there is a problem with emergency voltage output	00 – 99 sec. (0 = Function disabled)	10 sec.
17	Generator over frequency setting	51 – 75 Hz	65 Hz
18	Generator under frequency setting	40 – 59 Hz	55 Hz
19	Time delay if there is a problem with the Generator frequency	00 – 99 sec. (0 = Function disabled)	10 sec.
20	Set today's day of the week– Day	1 – 7 (Monday to Sunday)	current
21	Set today's hour – hour	00 – 23	Current
22	Set today's minutes	00 – 59	current
23	Set day of week to do the engine exercise	1 – 7 (Monday to Sunday)	6
24	Set the time to start the exercise	00 – 23 (24 Hr Mode)	12
25	Set generator automatic exercise cycle	01) 1 week 03) 3 weeks 02) 2 weeks 04) 4 weeks	01
26	Exercising duration	00 – 99 minutes (0 = Do not exercise)	00
27	Exercise with load or without load	00) Without load 01) With load	00
28	Test with load or without load	00) Without load 01) With load	01
29	Display setting	00) Cyclic Mode 01) Fix Mode	00

Line	Description	Value	Factory Setting
30	Program the auxiliary contact output	00) Transfer failure 01) Pre-transfer 02) Pre-exerciser 03) When the ATS is in emergency position	01
31	Pre-transfer / Pre-exercising time delay before transfer load from one source to another source	00 – 99 sec.	10
32	Remote control by KCU-XX module	00 → Disable 01 → Enable	00
33	KCU-02 module address	00 → KCU-02 module restricted 01 – 99	00
34	KCU-02 module transmission rate	01 → 115200 04 → 19200 07 → 4800 02 → 57600 05 → 14400 08 → 2400 03 → 38400 06 → 9600 09 → 1200	03
35	Enter AC voltage correction	00 → No 01 → Yes	00
36	Restore KCU Remote Connection Passwords to original factory default settings. (Administrator : 0000, Viewer : 9999)	00 → No 01 → Yes	00

3.10 Specification Summary

Description	Specification
AC Voltage Input Range	50 – 280 Vac 50/60 Hz
AC Voltage Display Range	50 – 550 Vac 50/60 Hz
Frequency Measurement Range	40 – 75 Hz
Remote Start Contact	7A @ 250 Vac Max
Normal ON Contact	7A @ 250 Vac Max
Emergency ON Contact	7A @ 250 Vac Max
Auxiliary Contact Output	7A @ 250 Vac Max
Operating Temperature	-20 to +70 °C
Storage Temperature	-30 to +80 °C
Relative Humidity	Max. 90%
Panel Cut-Out	168.0 (L) x 113.0 (W) +/- 0.5 mm
Dimensions	180.0 (L) x 125.0 (W) x 42.0 (H) mm
Weight	495 g +/- 2%

SECTION 4: INSTALLATION INSTRUCTIONS

4.1 General

The ATS-22A is made for front panel mounting.

4.2 Figure / Size / Installation Reference (All Dimensions in mm.)

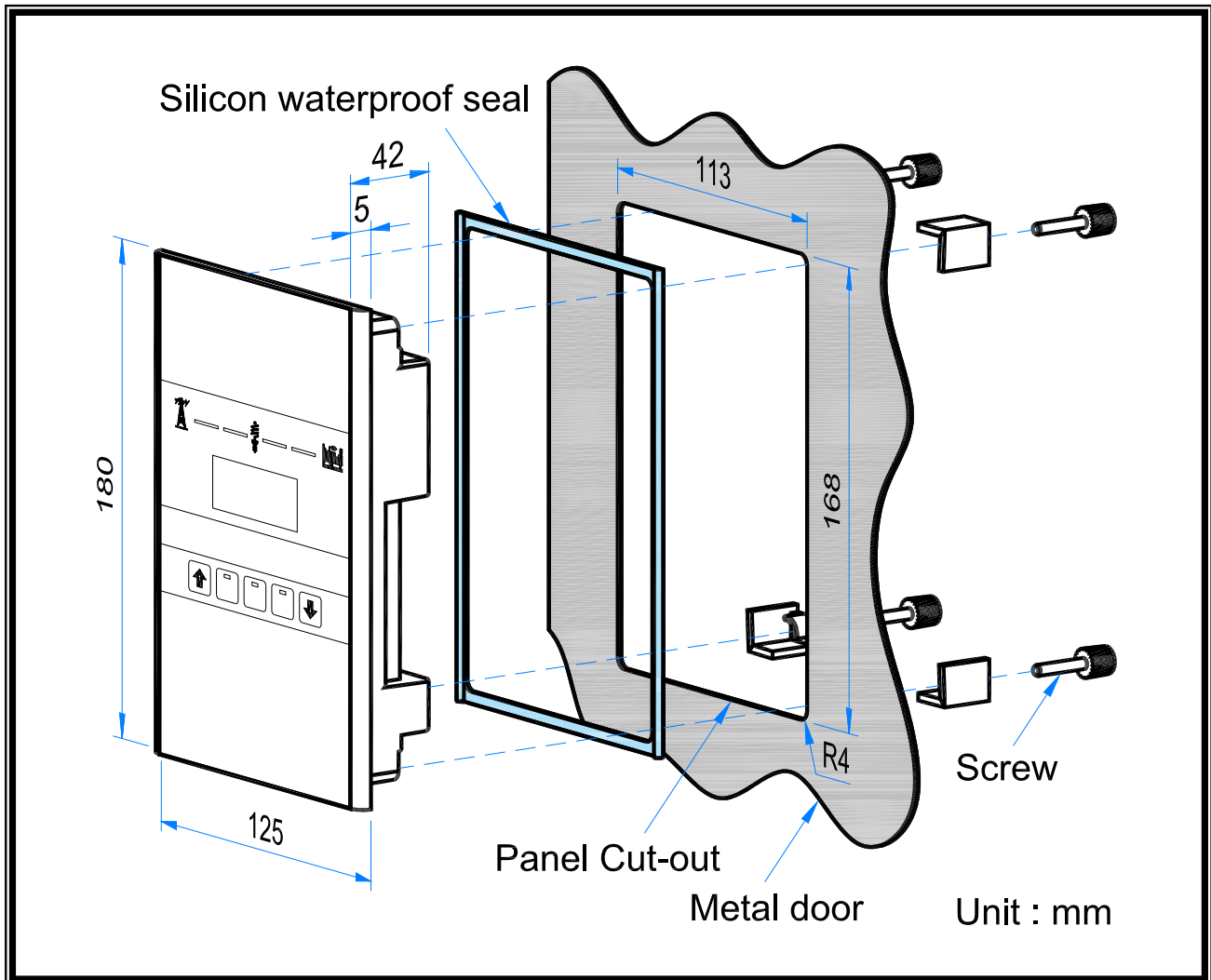

SECTION 5 : TYPICAL WIRING

5.1 Single motor MCCB Type ATS Wiring Diagram (3P/4P 220 Vac) – Called BTS Switch

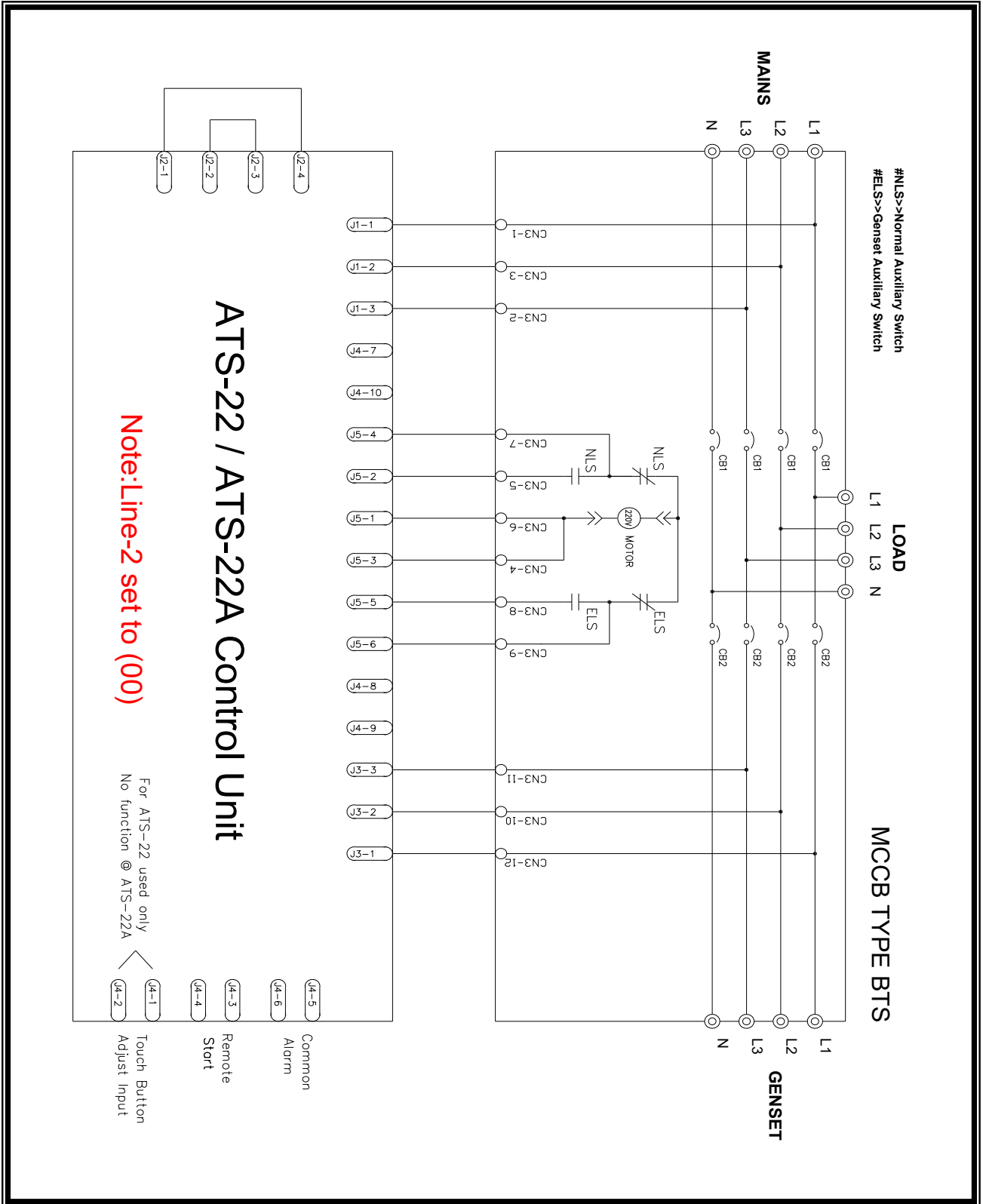

5.2 Single Motor MCCB Type ATS Wiring Diagram (2P 220 Vac)

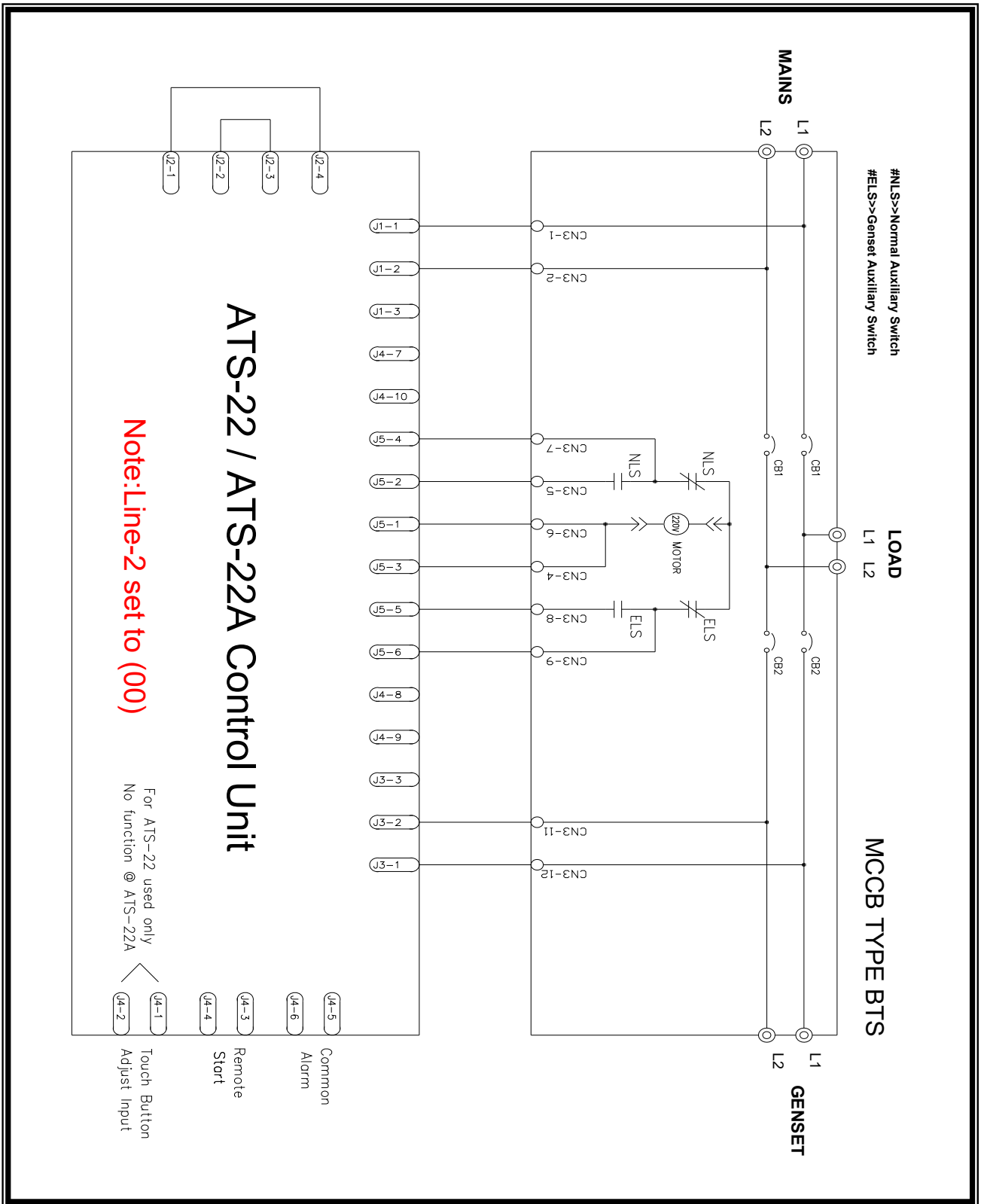

5.3 TERASAKI MOT Type ATS Wiring Diagram (3P/4P 220 Vac) – MCCB With Separate Motor

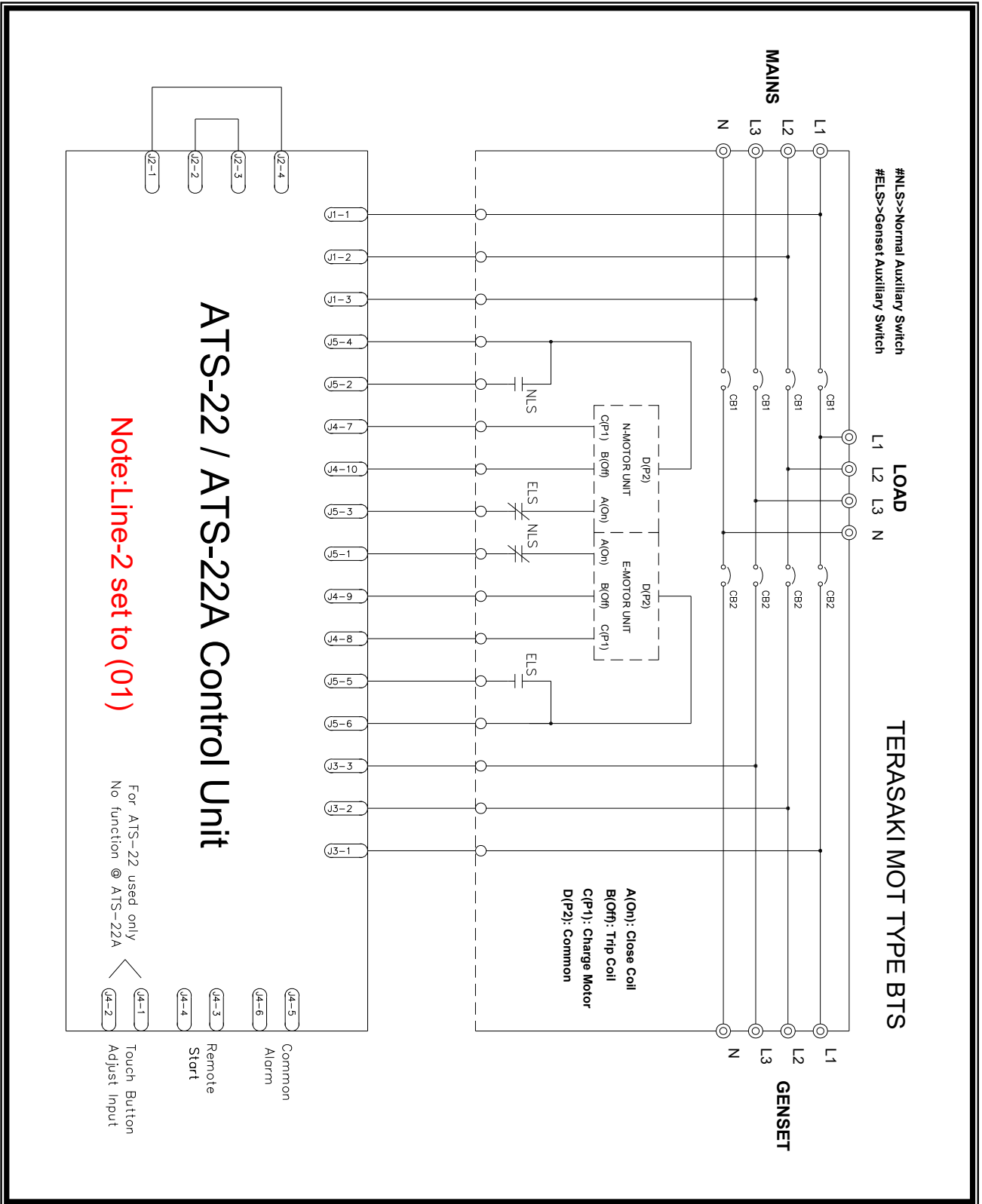

5.4 TERASAKI MOT Type ATS Wiring Diagram (2P 220 Vac) – MCCB With Separate Motor

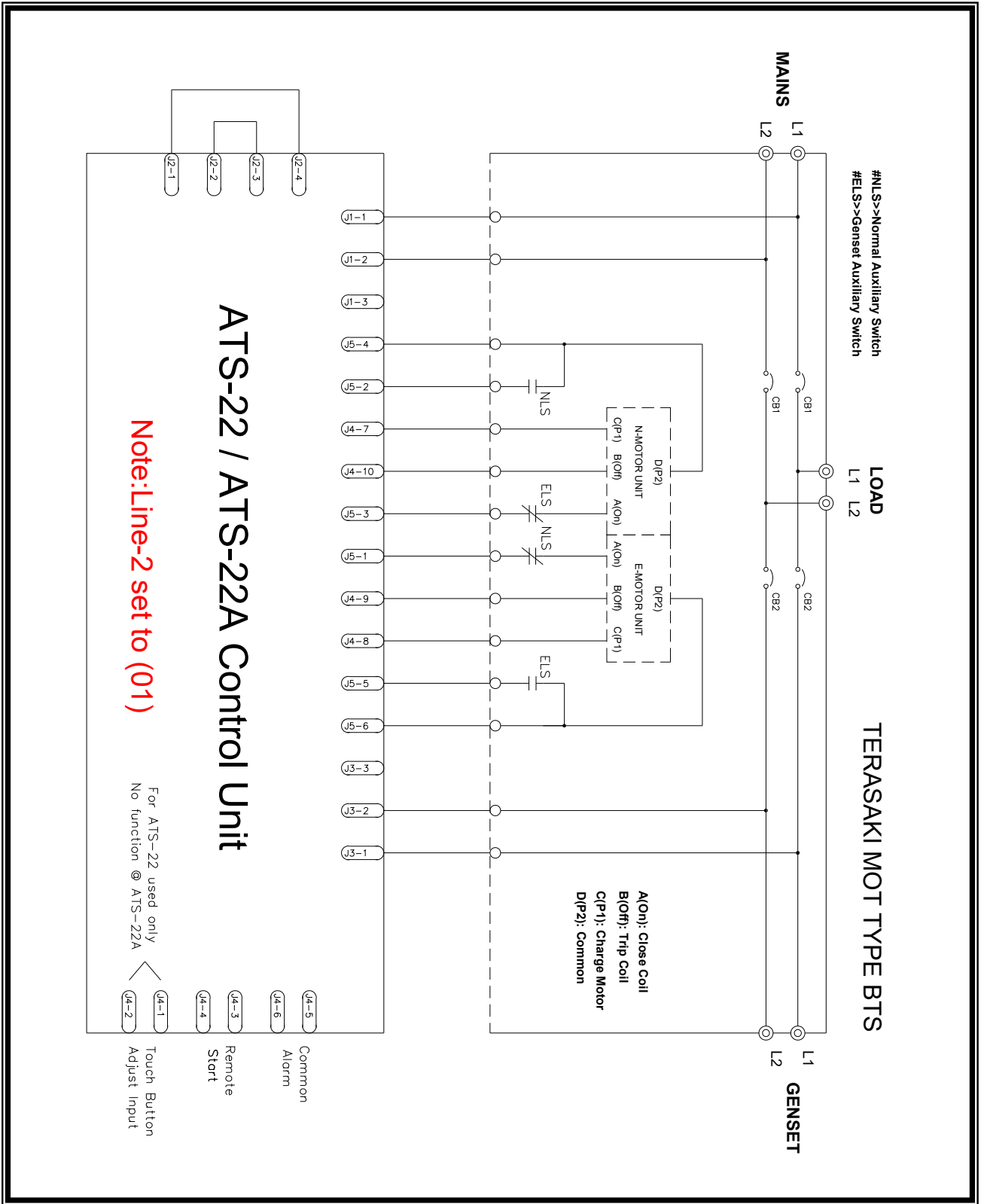

5.5 MITSUBISHI MD Type ATS Wiring Diagram (3P/4P 220 Vac) – MCCB With Separate Motor

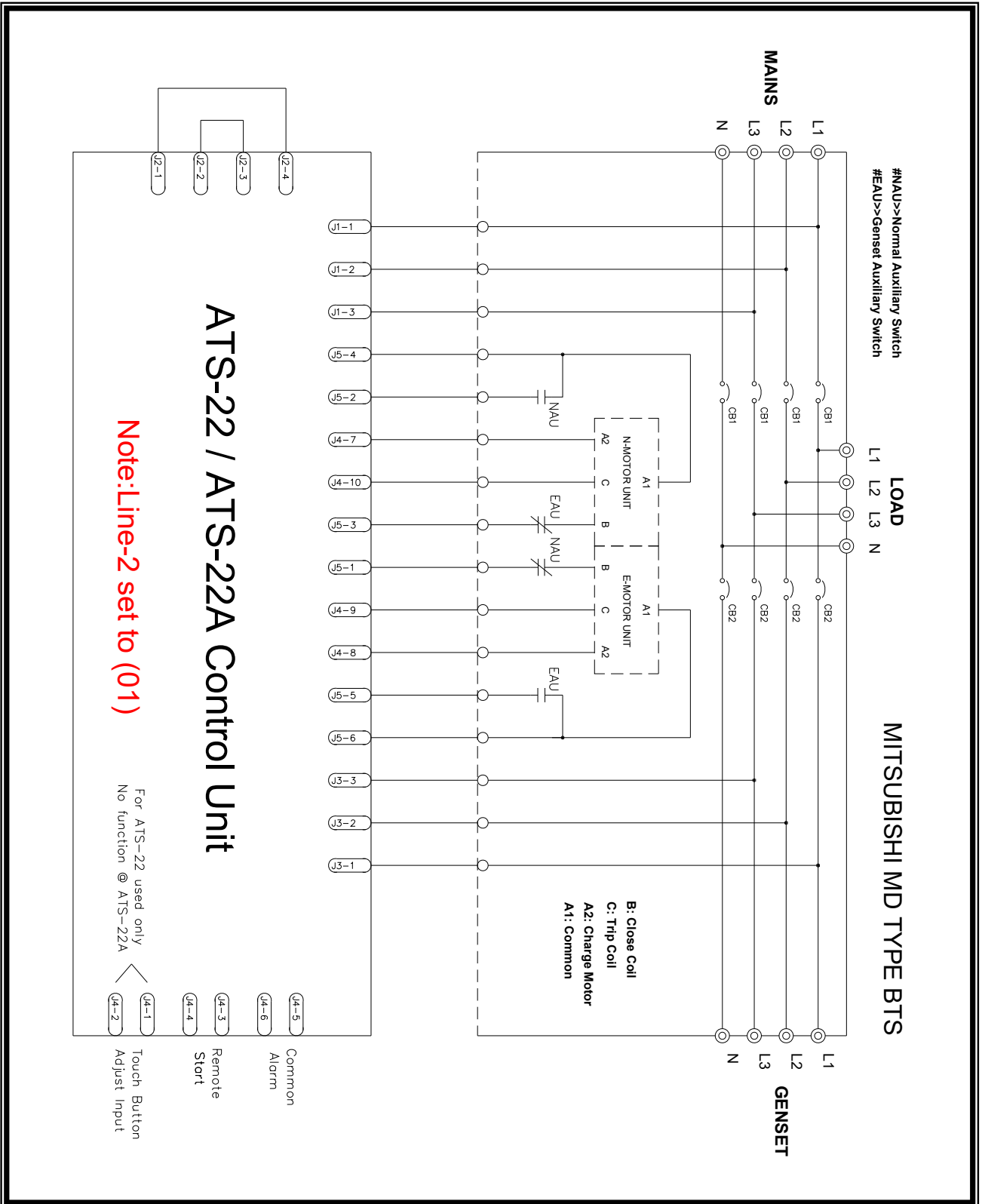

5.6 MITSUBISHI MD Type ATS Wiring Diagram (2P 220 Vac) – MCCB With Separate Motor

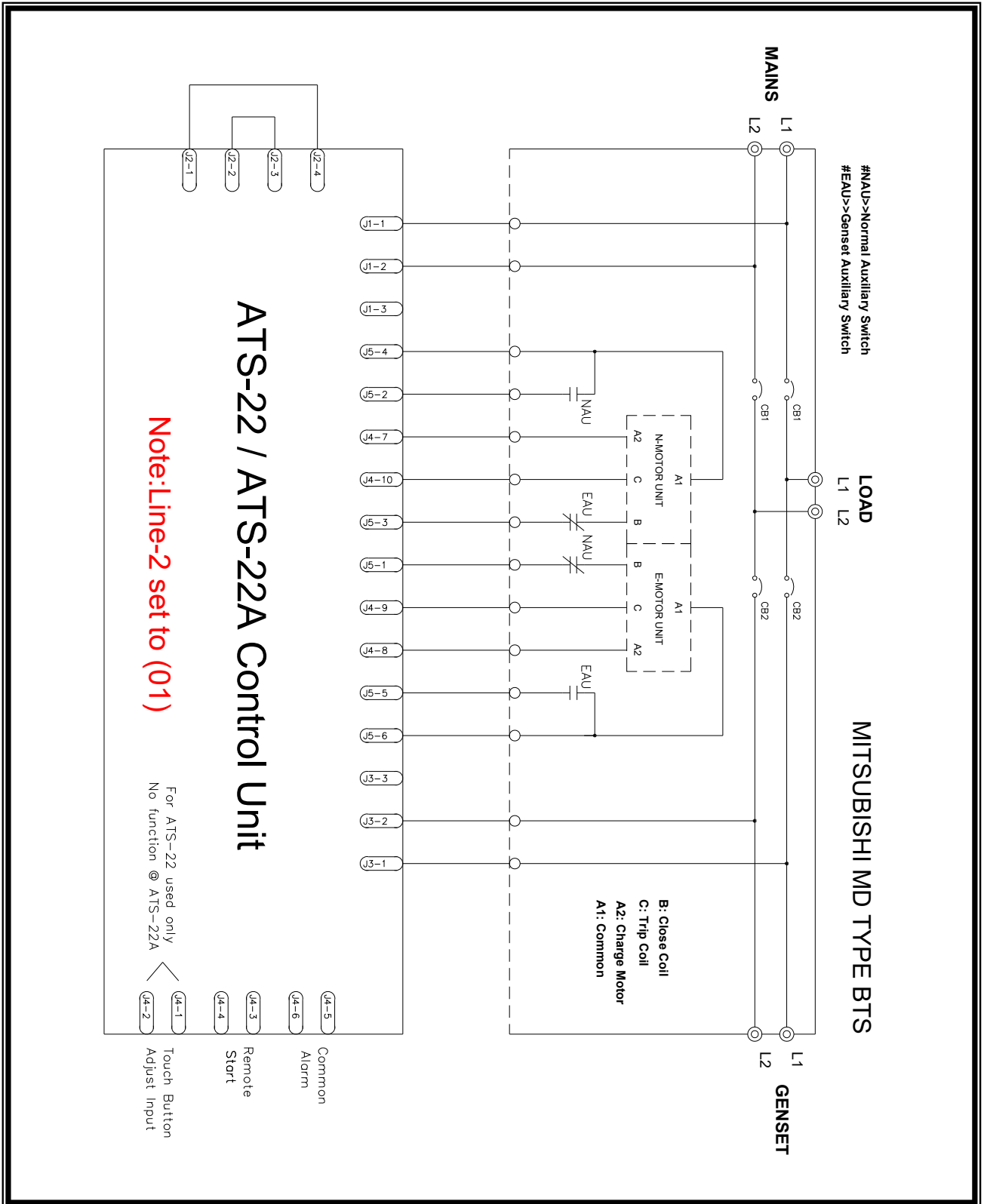

5.7 Air Circuit Breaker Type ATS Wiring Diagram (3P/4P 220 Vac)
 Merlin Gerin MCB Type ATS Wiring Diagram (3P/4P 220 Vac)

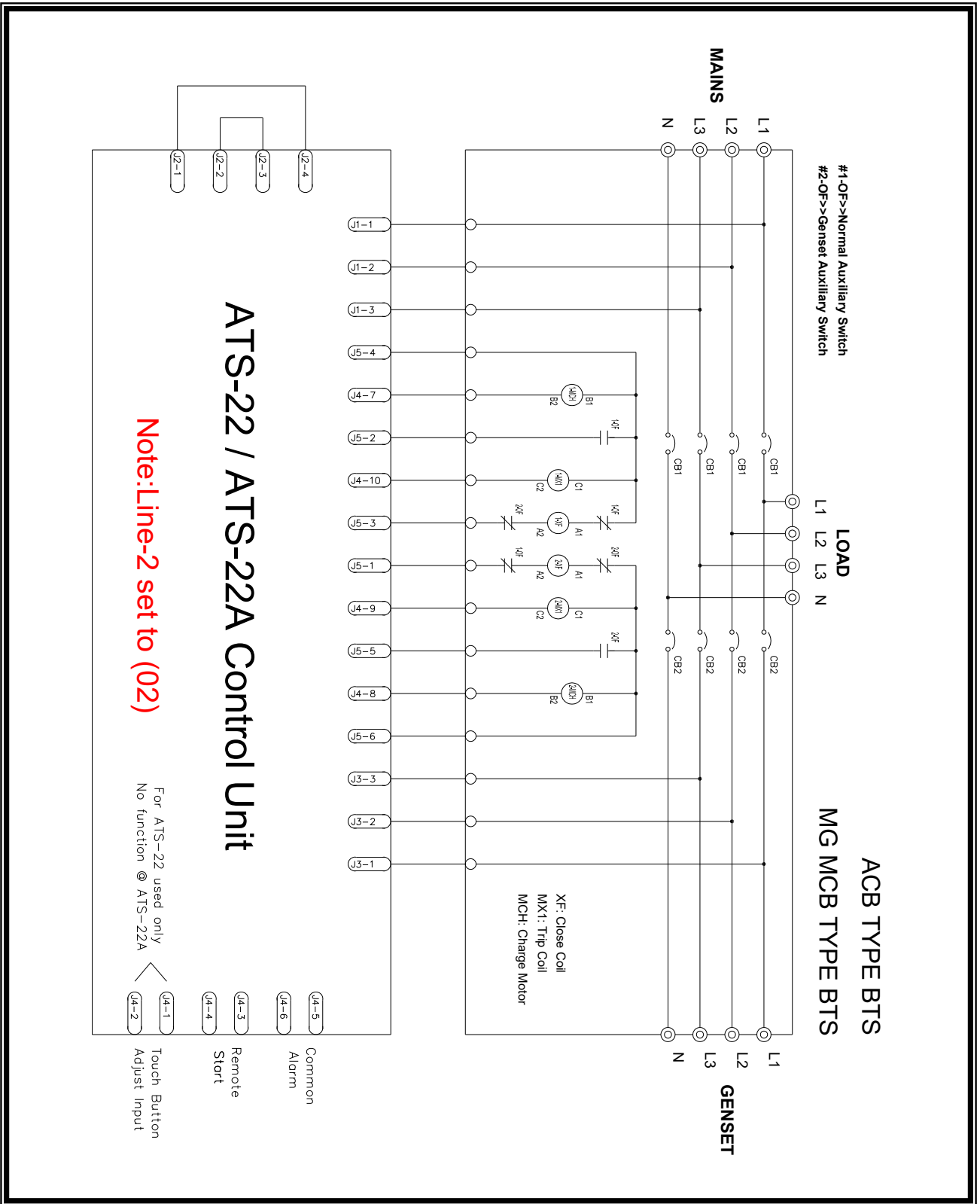

5.8 Air Circuit Breaker Type ATS Wiring Diagram (2P 220 Vac)
 Merlin Gerin MCB Type ATS Wiring Diagram (2P 220 Vac)

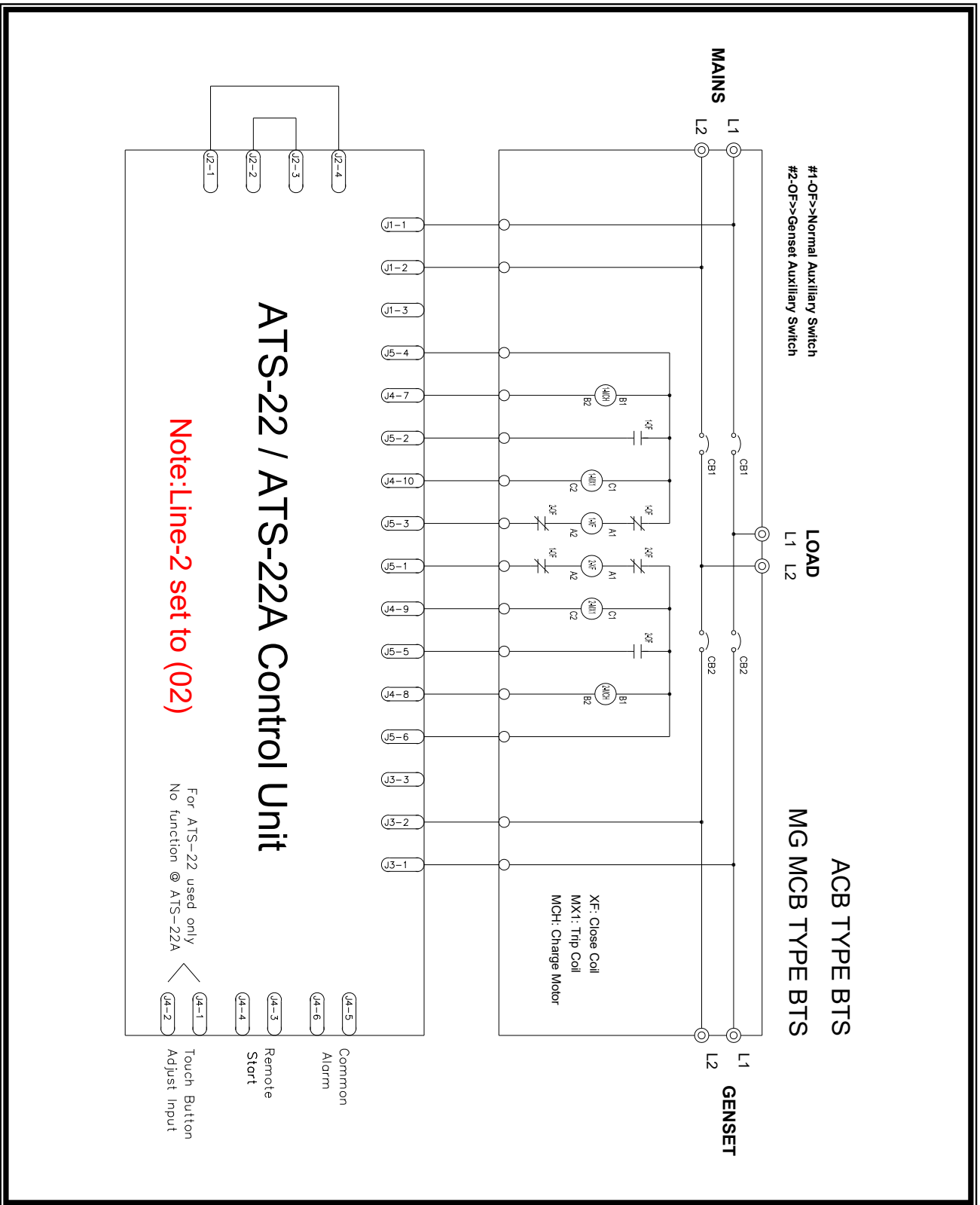

5.9 Double Throw Type ATS Without OFF Position Wiring Diagram (3P/4P 220 Vac) – With A1, A2 & B1, B2

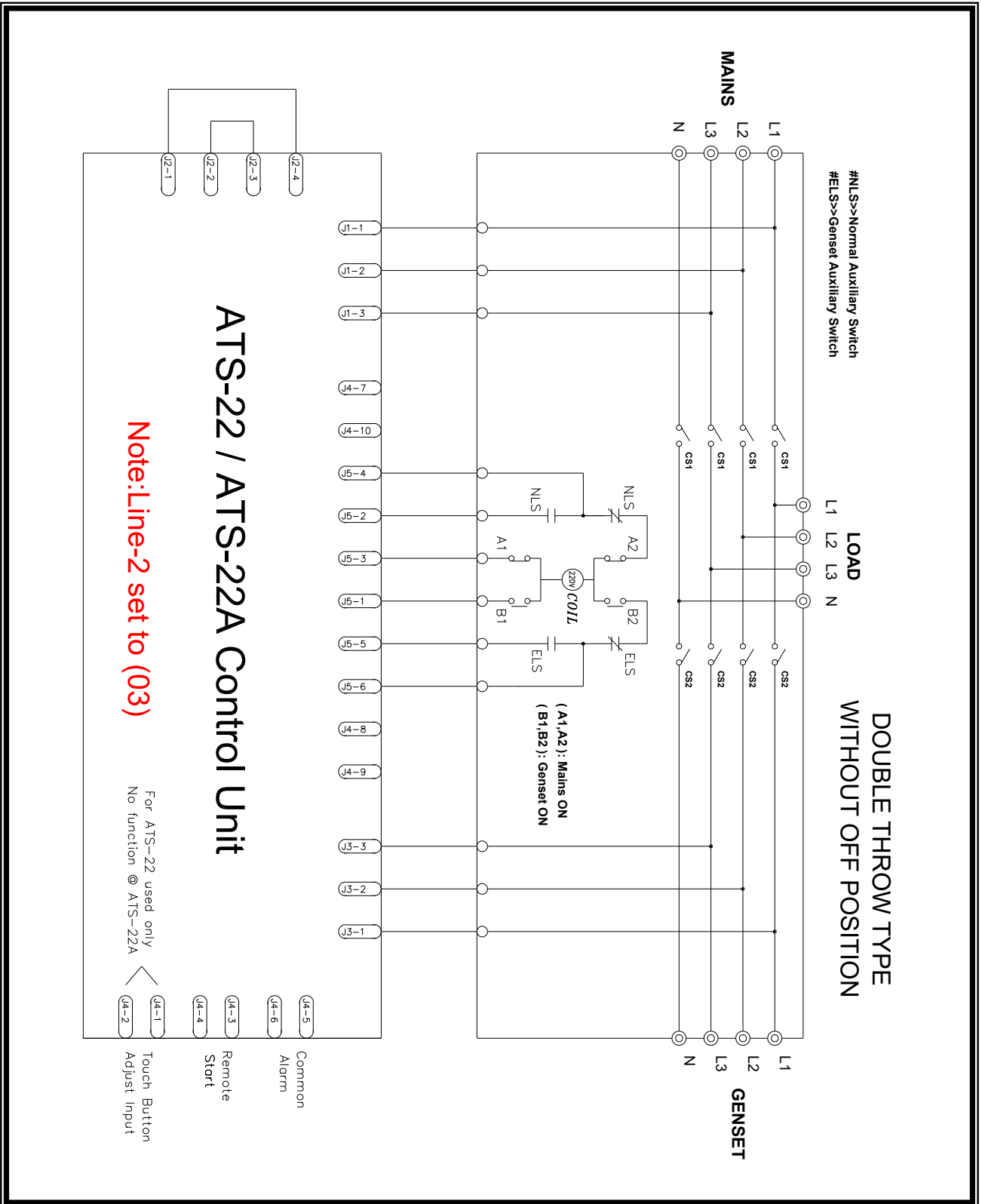

5.10 Double Throw Type ATS Without OFF Position Wiring Diagram (2P 220 Vac) – With A1, A2 & B1, B2

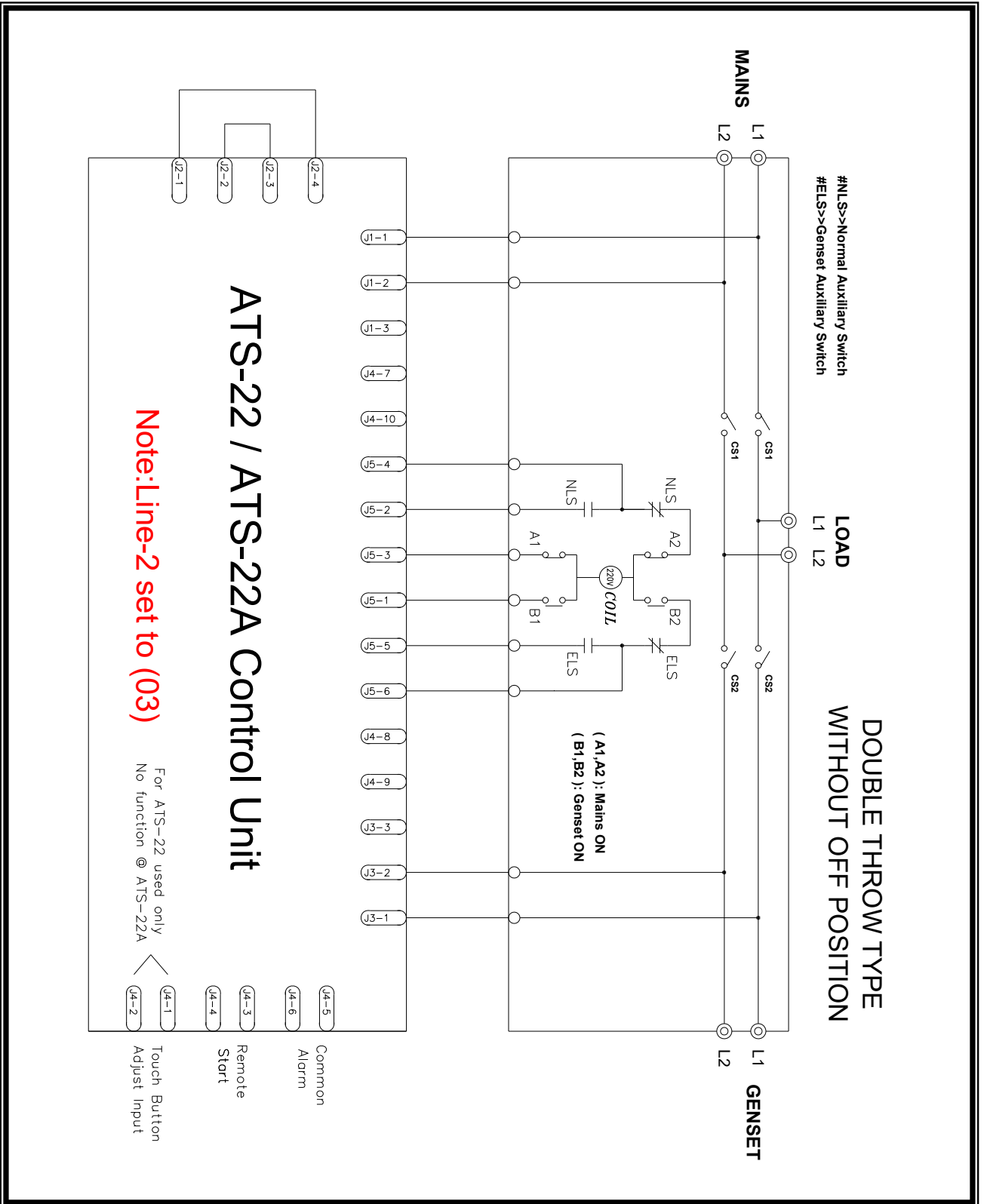

5.11 Double Throw Type ATS Without OFF Position Wiring Diagram (3P/4P 220 Vac) – With S1 & S2 Coils

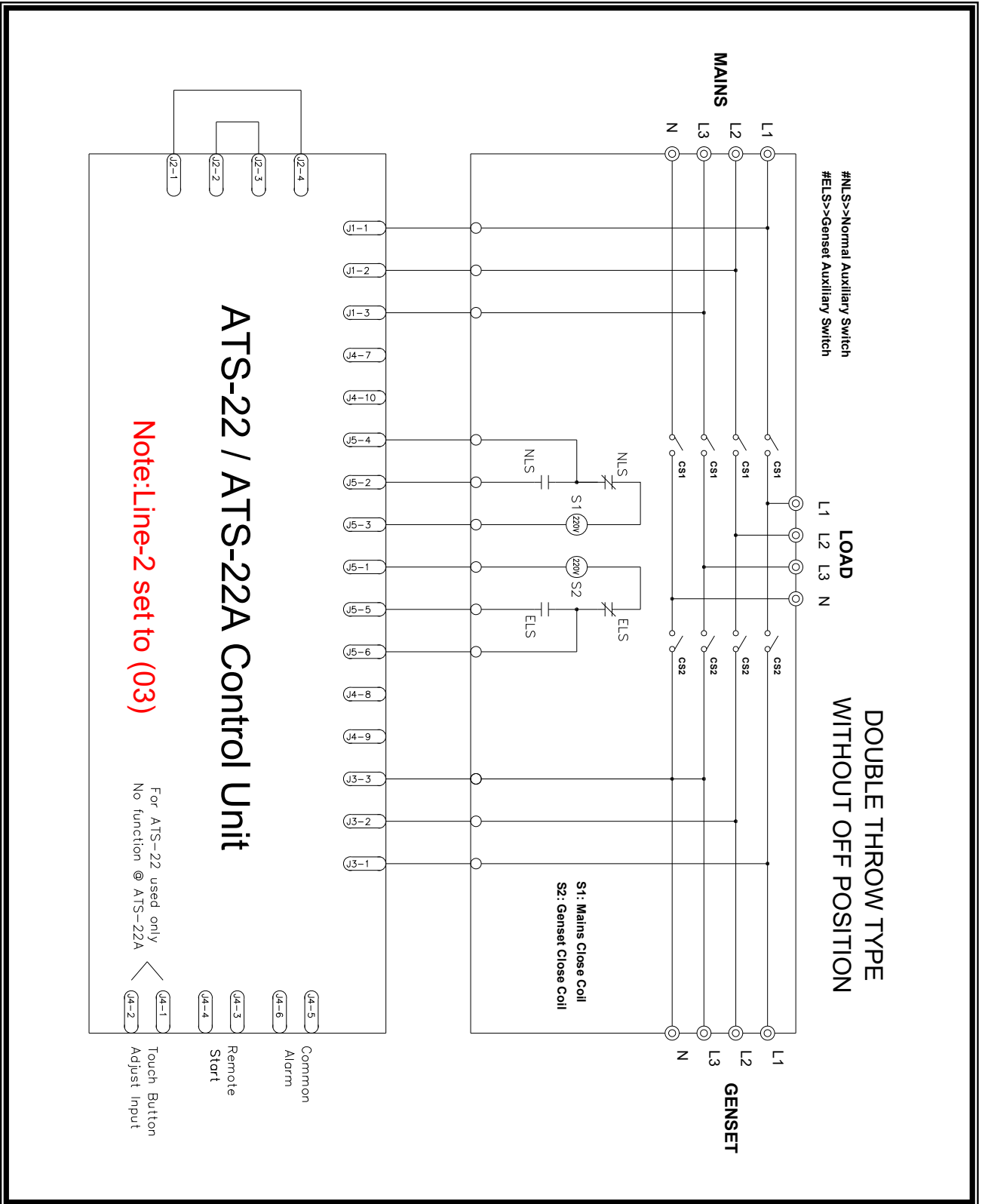

5.12 Double Throw Type ATS Without OFF Position Wiring Diagram (2P 220 Vac) – With S1 & S2 Coils

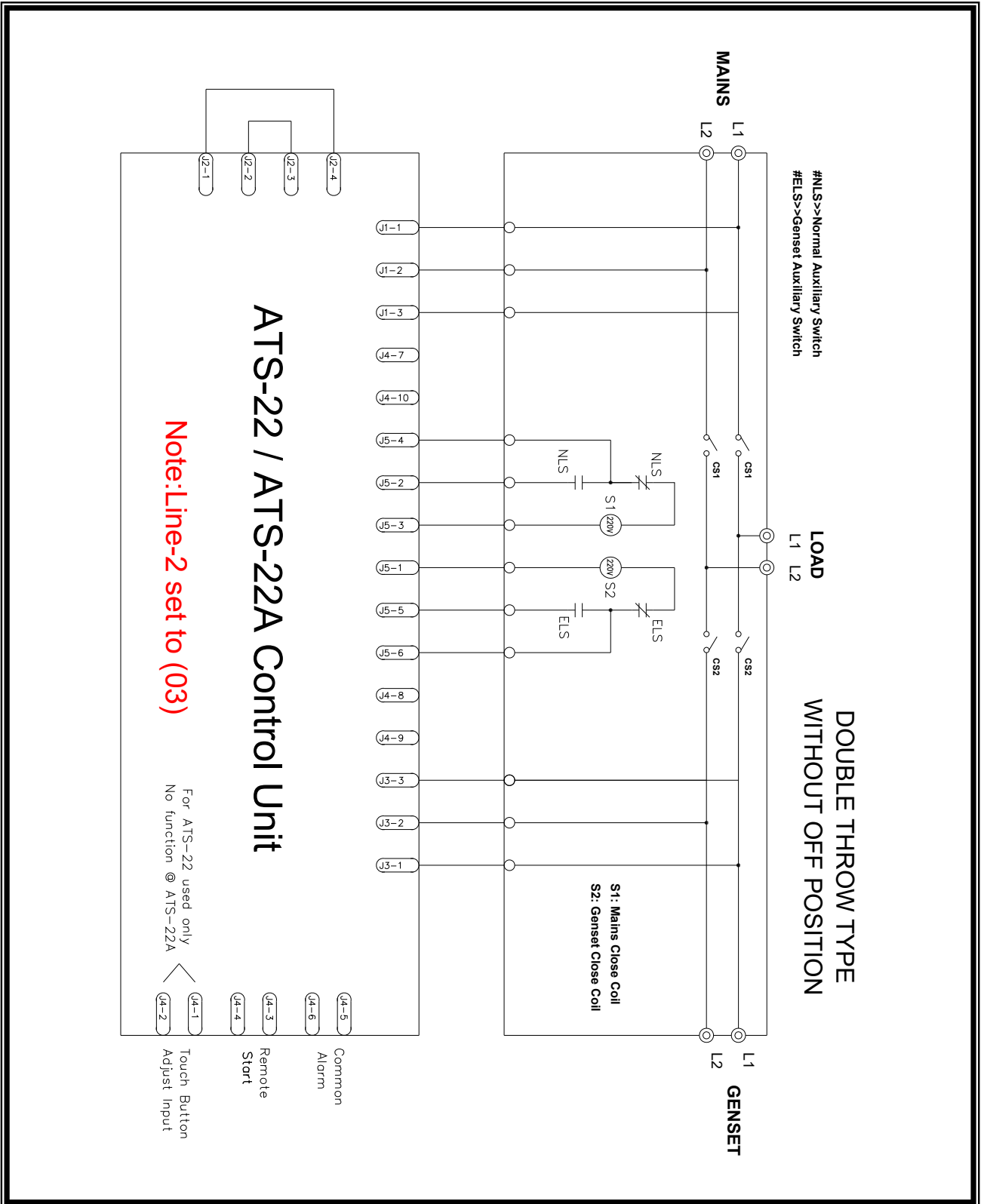

**5.13 Double Throw Type ATS With OFF Position Wiring Diagram (3P/4P 220 Vac)
With A1,A2 & AT1,AT2 & B1,B2 & BT1,BT2 Terminals**

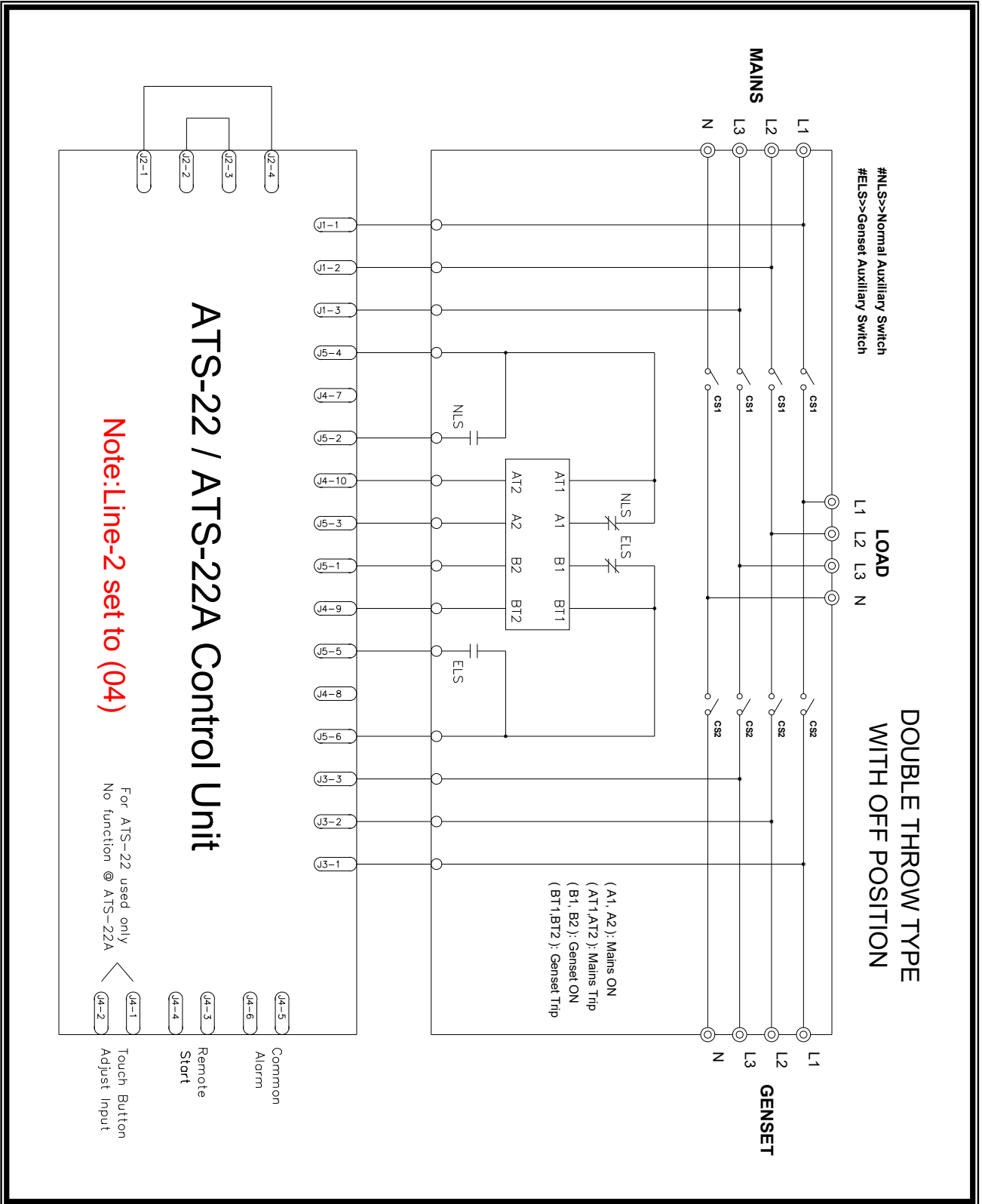

**5.14 Double Throw Type ATS With OFF Position Wiring Diagram (2P 220 Vac)
With A1,A2 & AT1,AT2 & B1,B2 & BT1,BT2 Terminals**

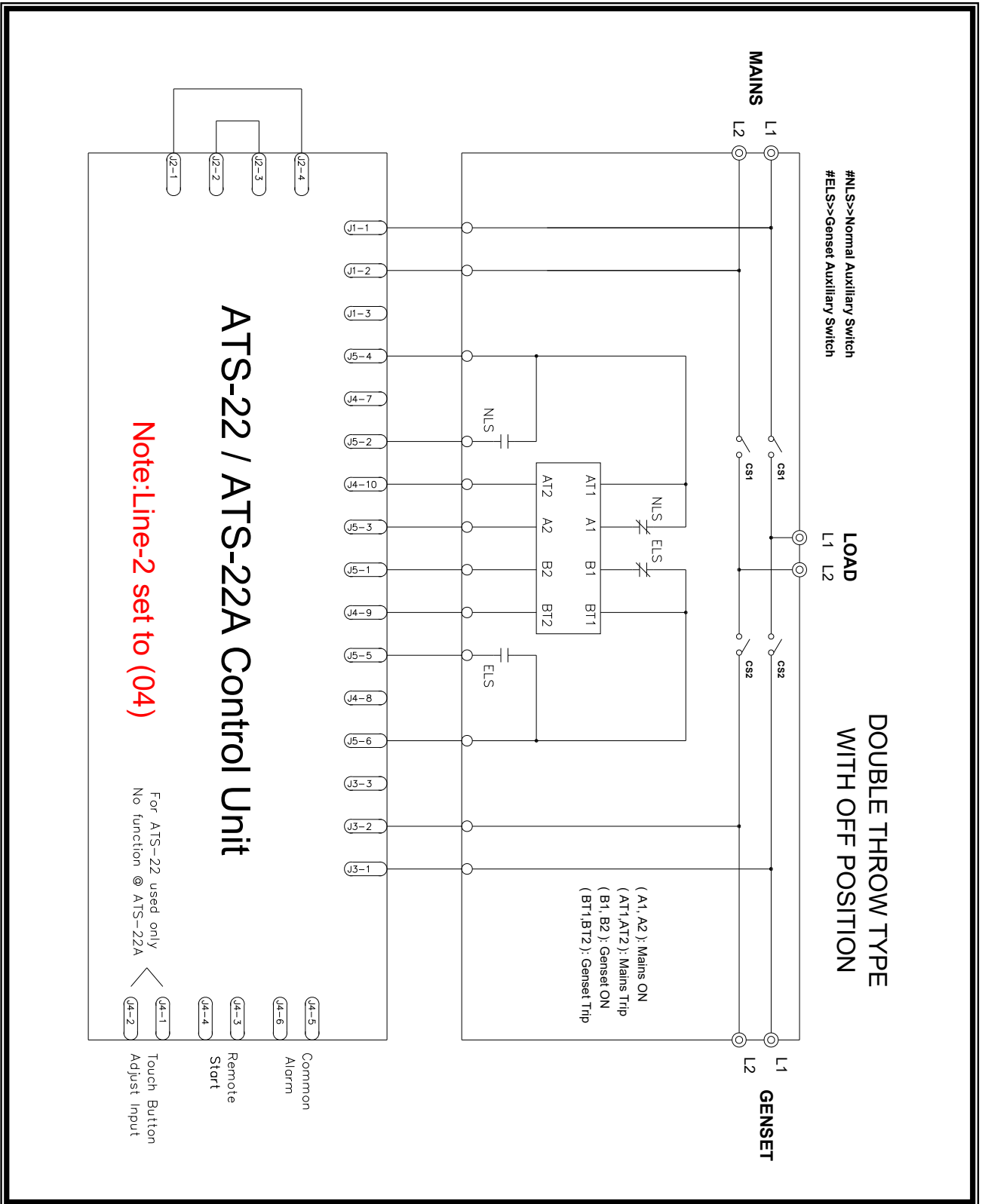

5.15 SOCOMEC ATyS-3e & ATyS-6 & ATyS-6e Type ATS Wiring Diagram (3P/4P 220 Vac)

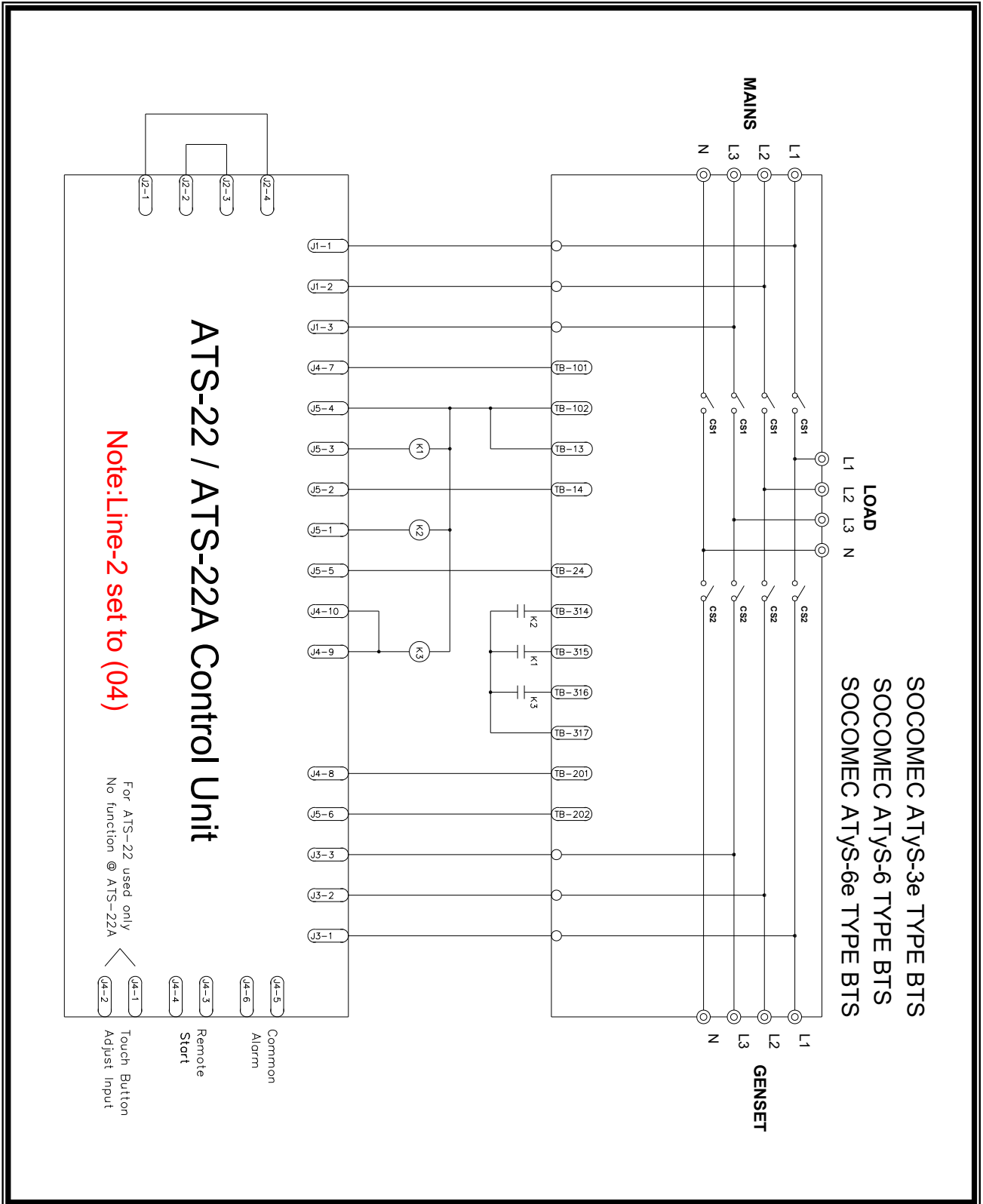

5.16 SOCOMEC ATYS-3e & ATYS-6 & ATYS-6e Type ATS Wiring Diagram (2P 220 Vac)

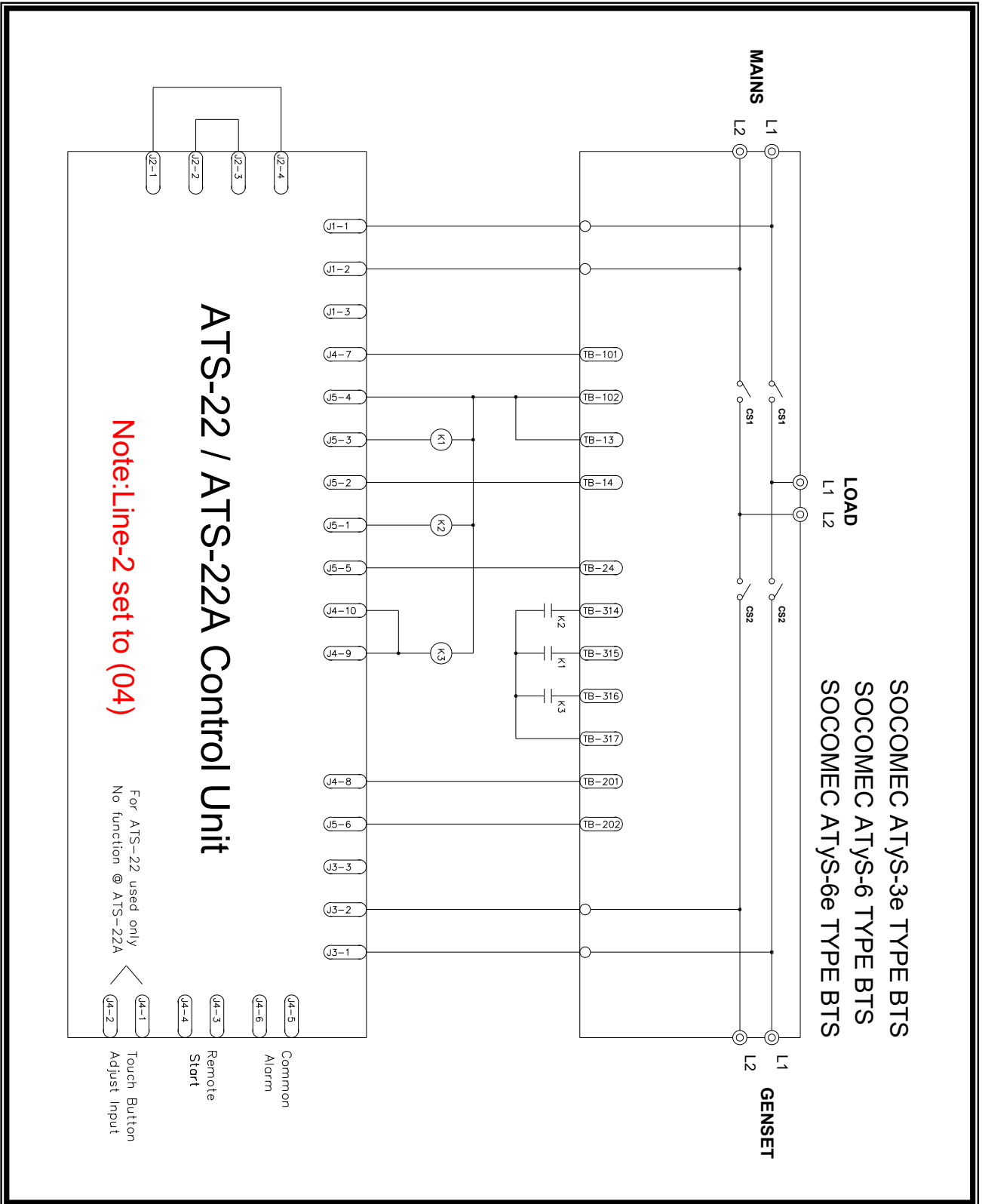

5.17 SOCOMEC ATyS-3S type ATS Wiring Diagram (3P/4P 220 Vac)

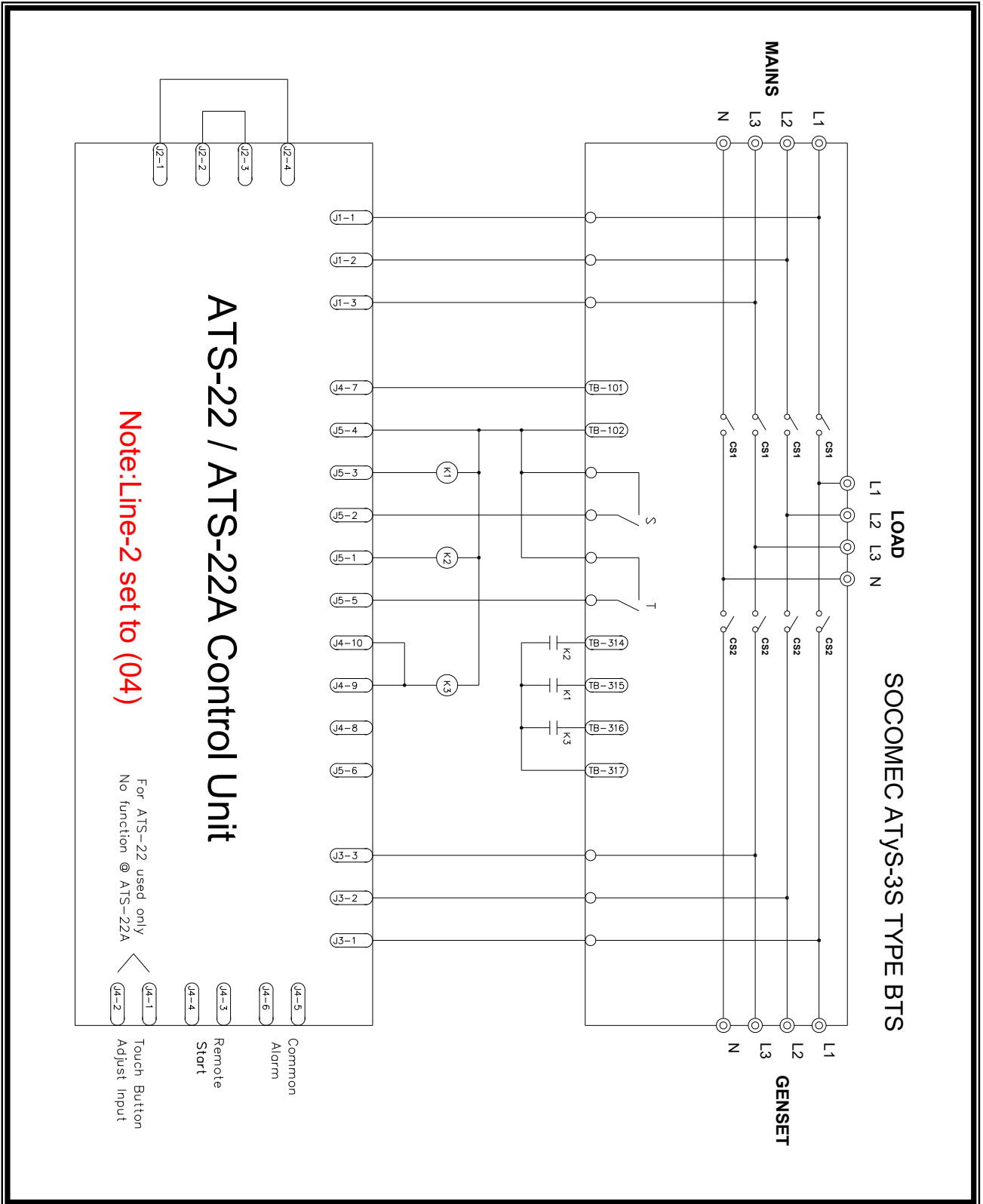

5.18 SOCOMEC ATyS-3S type ATS Wiring Diagram (2P 220 Vac)

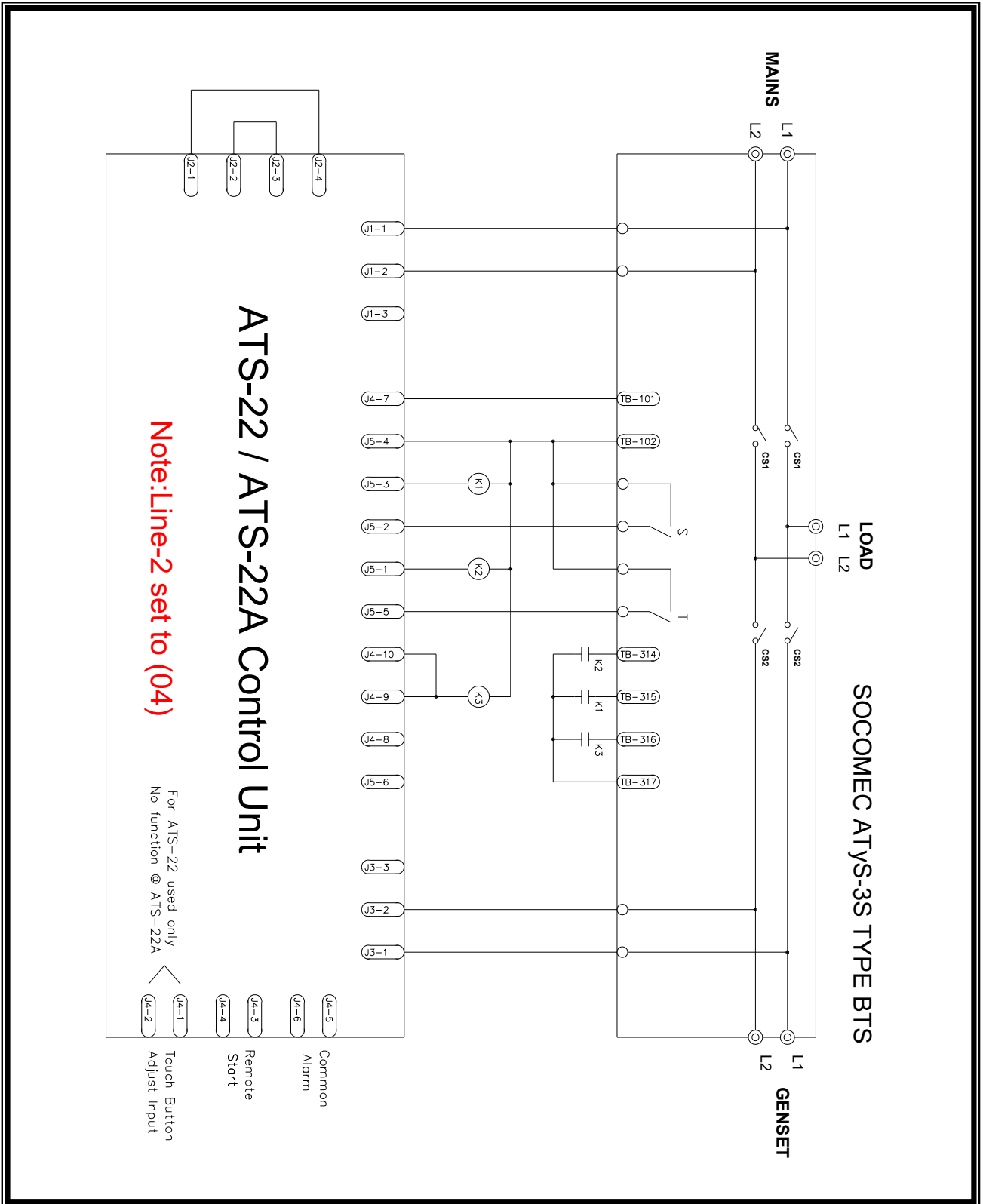

5.19 KUTAI TS-XXX Type ATS Wiring Diagram (3P/4P 220 Vac)

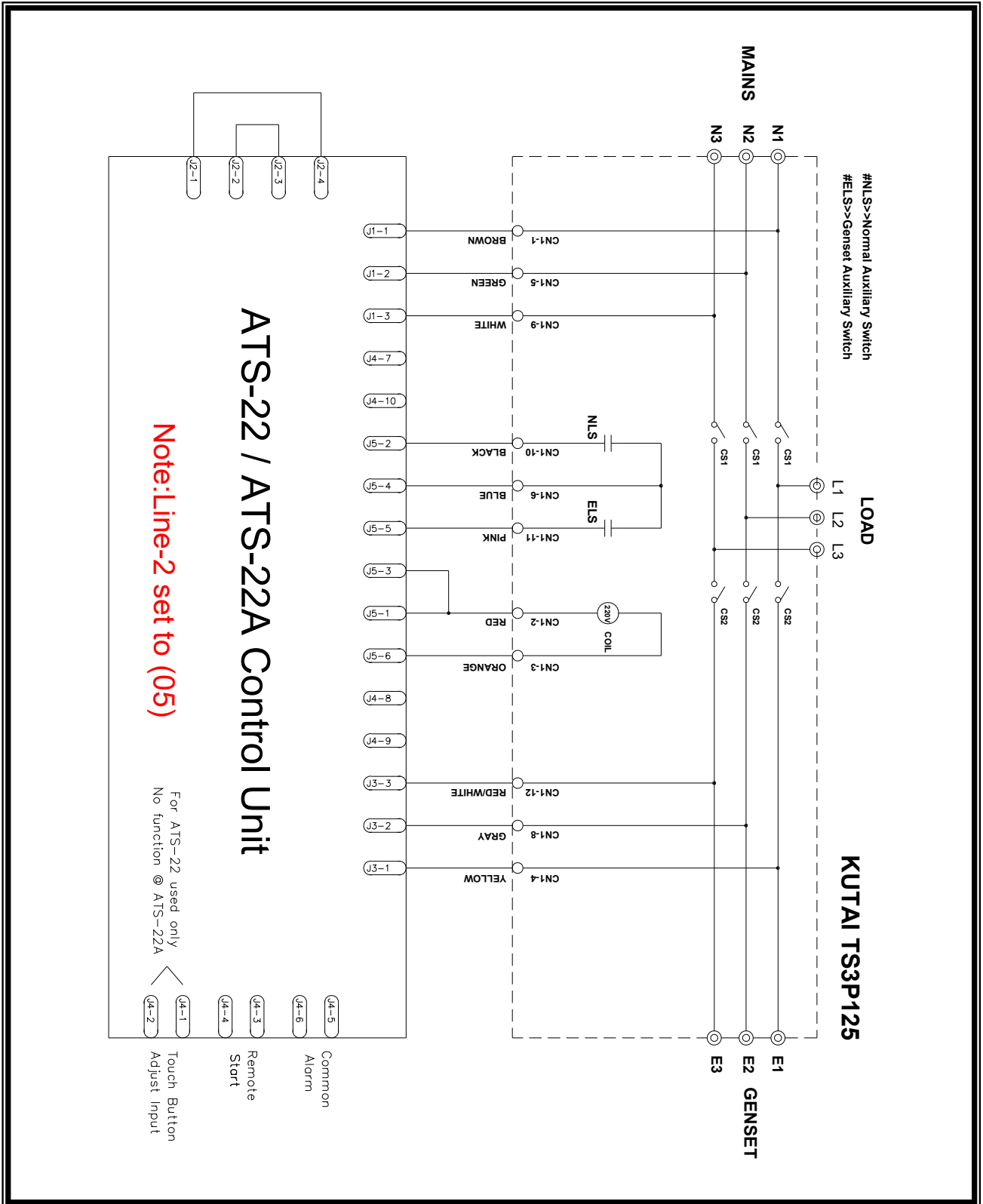

5.20 KUTAI TS-XXX Type ATS Wiring Diagram (2P 220 Vac)

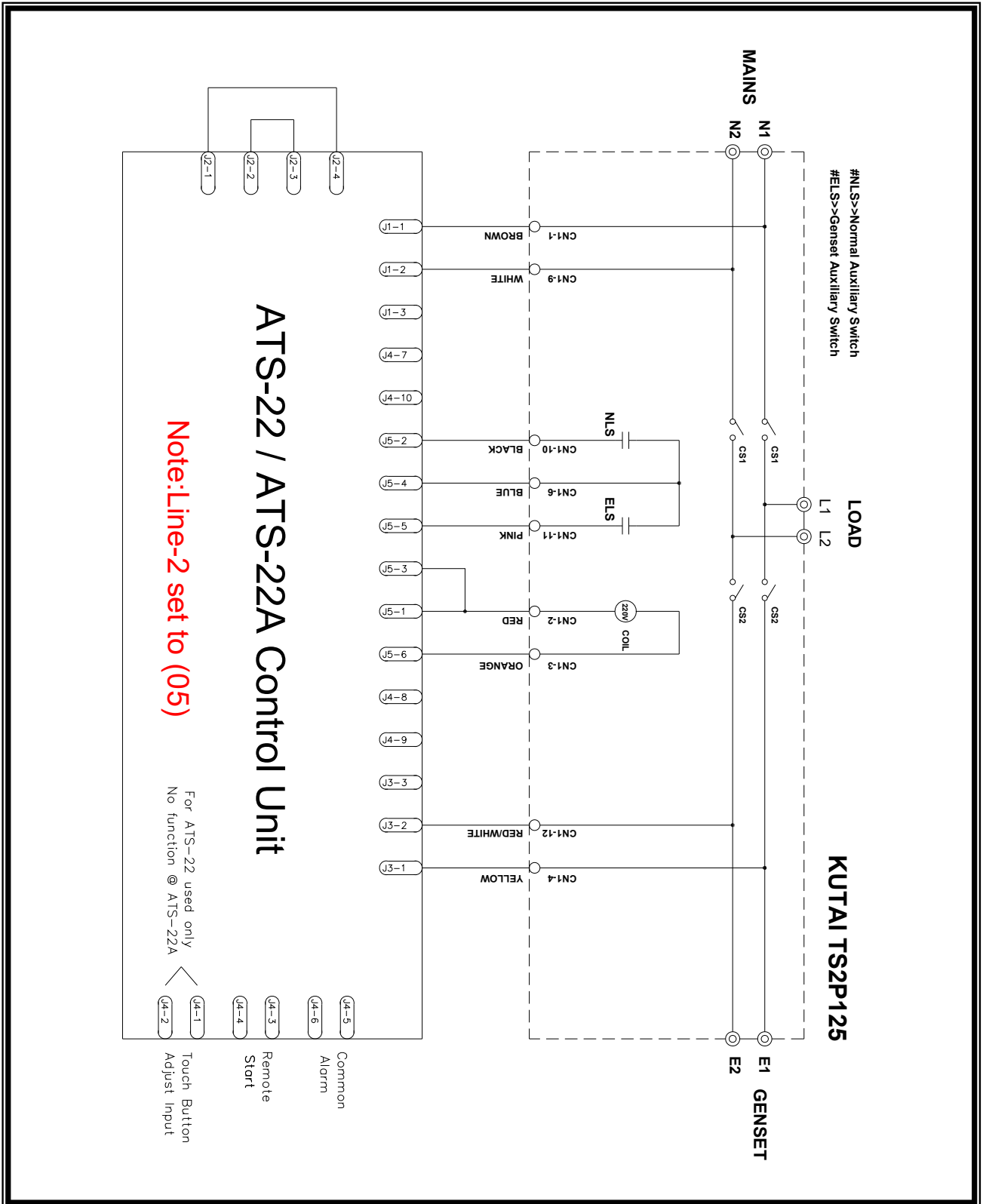

5.21 Magnetic Contactor Type ATS Wiring Diagram (3P/4P 220 Vac)

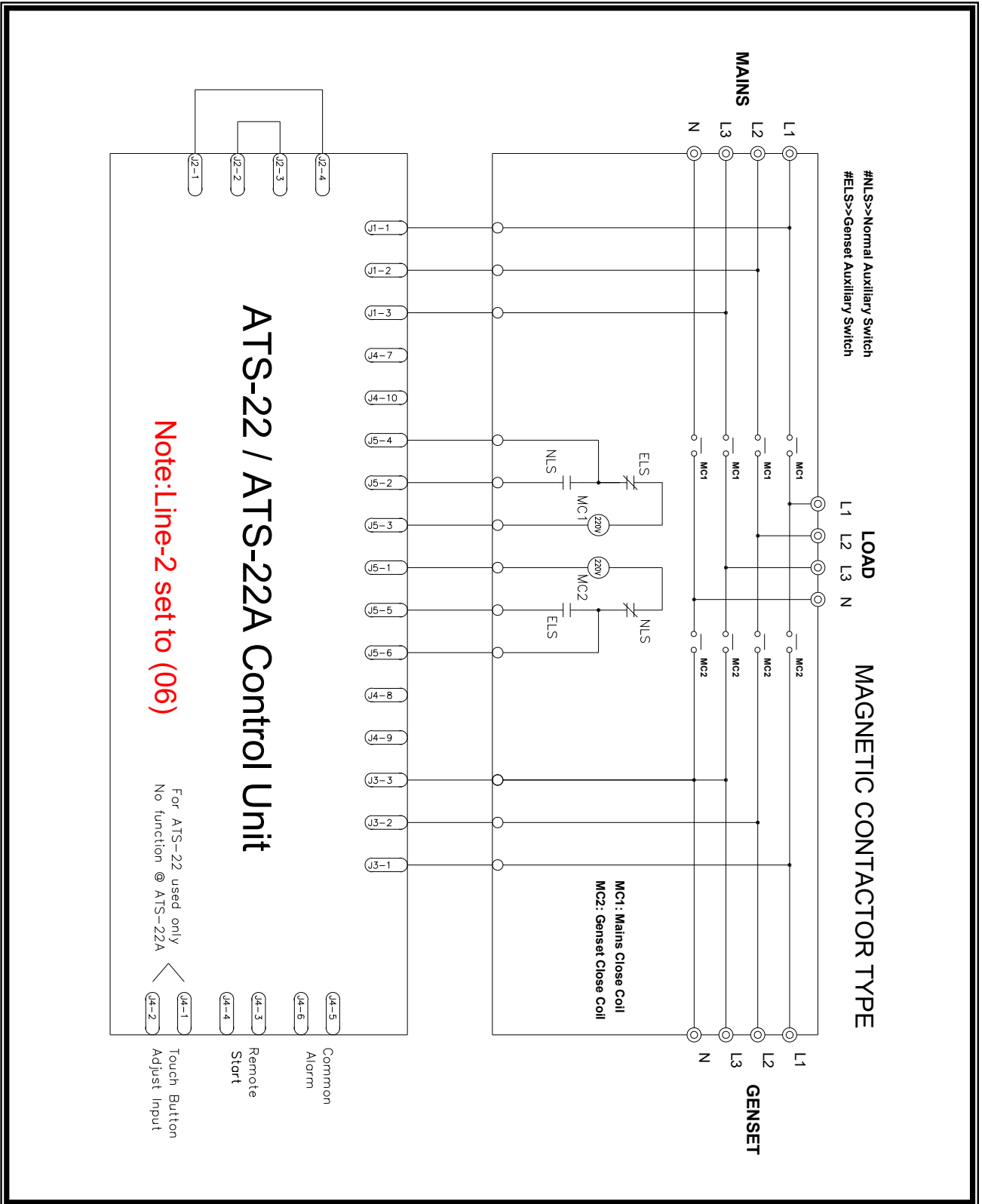



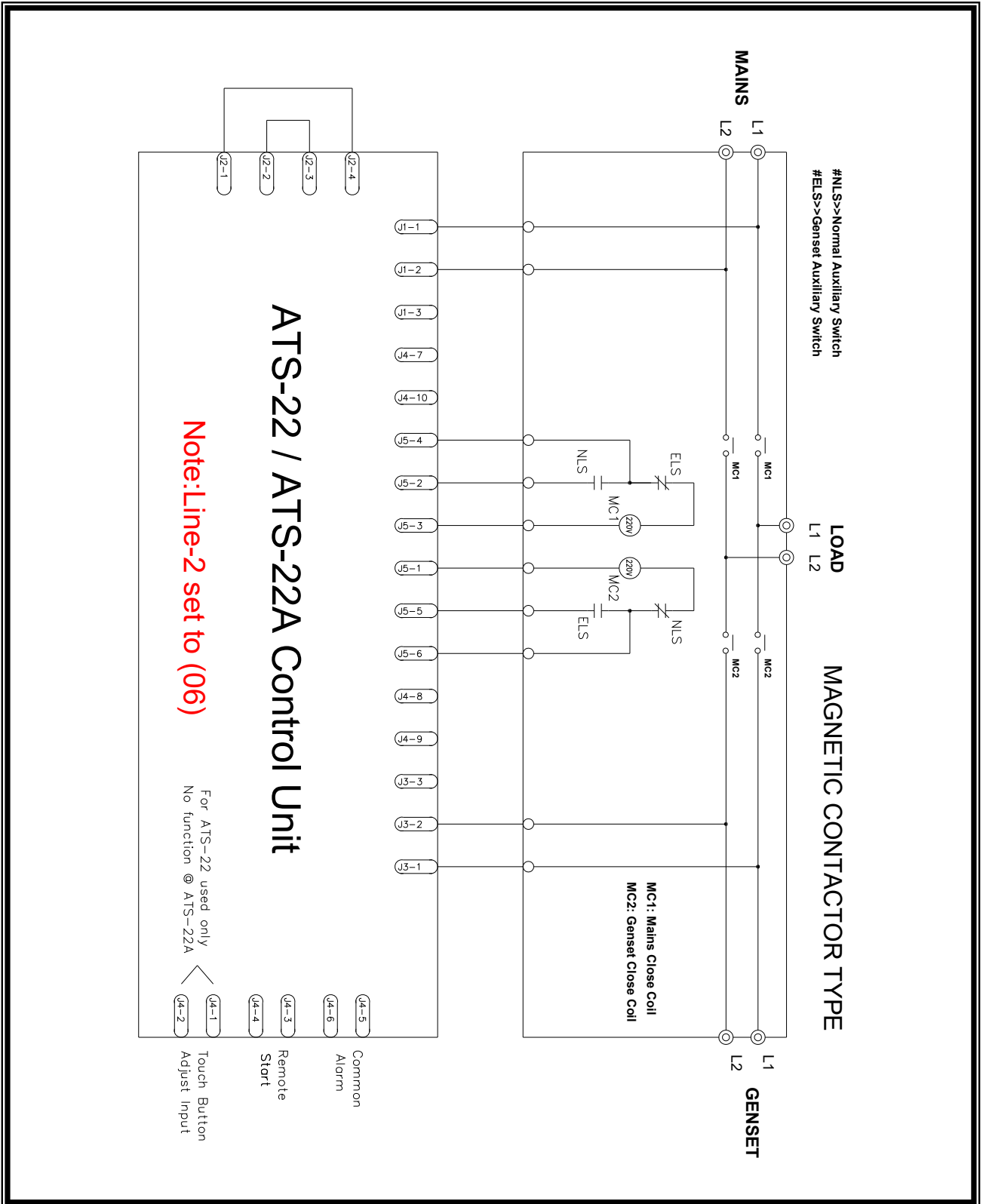



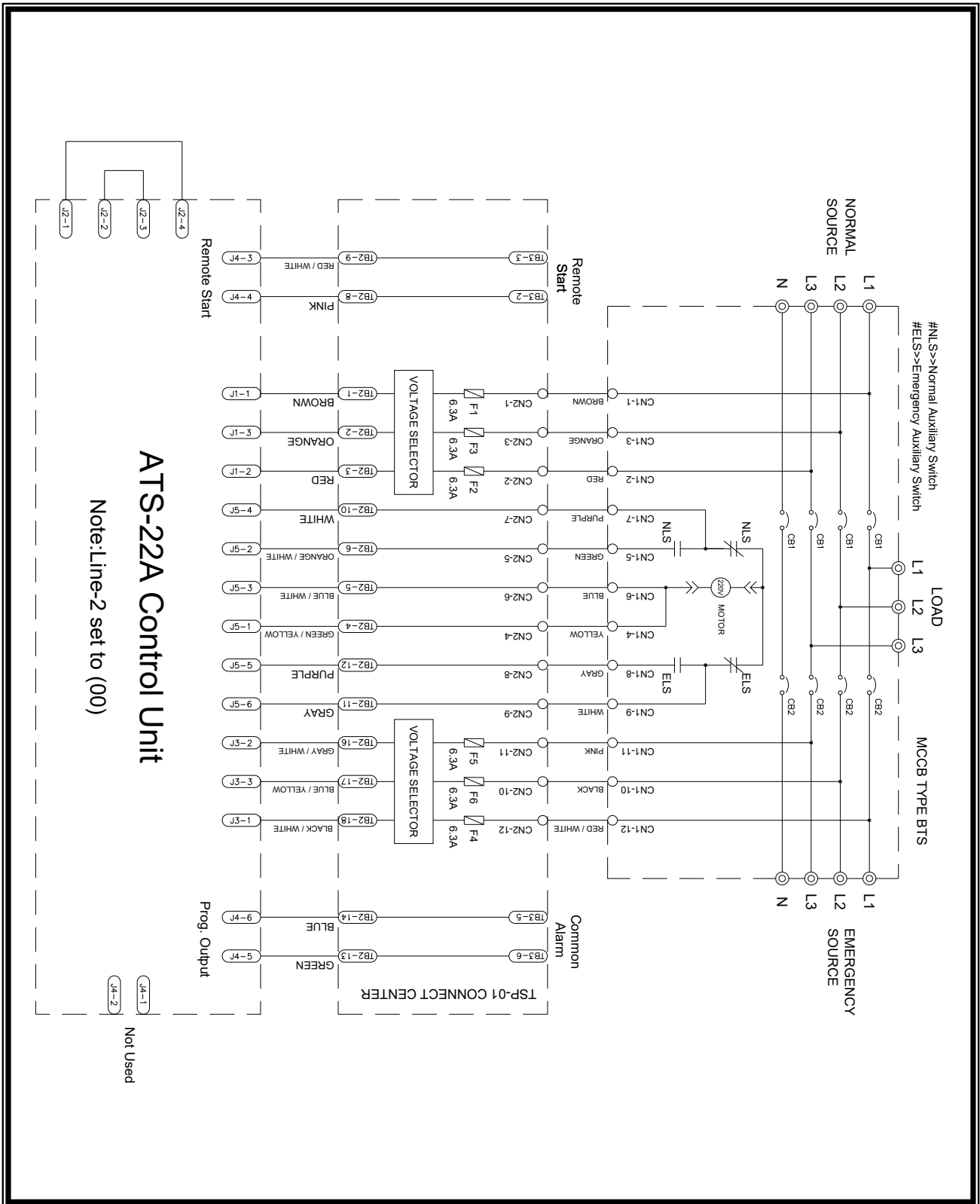

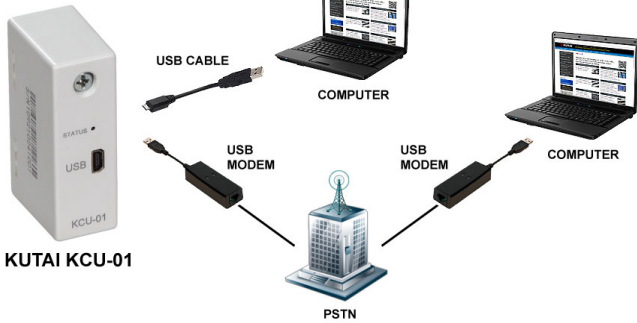

5.22 Magnetic Contactor Type ATS Wiring Diagram (2P 220 Vac)

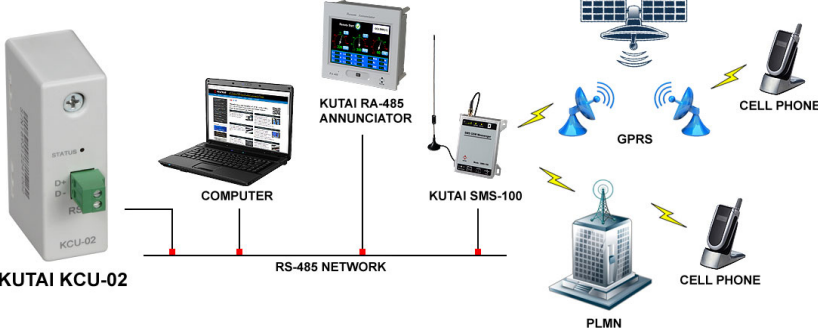

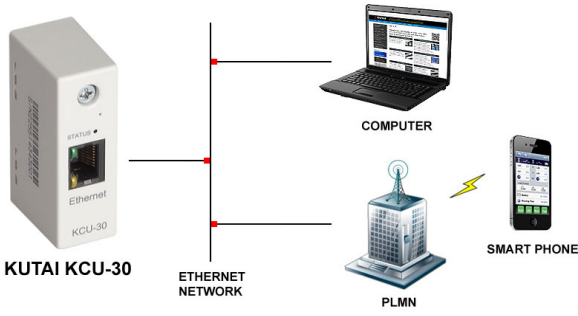
5.23 ATS-22A with TSP-01 Wiring Diagram (3 Phase 4 Wire, for system voltage is different from 220V)



APPENDIX : KCU Modules Connection Illustration

Remote Communication Function Supported Models	KUTAI Remote Communication Modules
 <p>AMF-10</p>	<p>1 KCU-01 (USB Module)</p> 
 <p>GCU-100</p>	<p>2 KCU-02 (RS-485 Module)</p> 
 <p>ATS-22A</p>	<p>3 KCU-30 (Ethernet Module)</p> 
 <p>ATS-33</p>	<p>4 KCU-40 (Wi-Fi Module)</p> 
 <p>ATS-34</p>	
 <p>ATS-PLC</p>	
 <p>GCU-3000</p>	